



# **Novo**Display

## **User Manual**

(For DK430 / DK550 / DK650 / DK750)

# Table of Contents

- Safety ..... 4**
  - Regulatory Compliance .....6
- Package Contents ..... 8**
- Overview ..... 9**
  - Display Front View .....9**
    - DK430 / DK550..... 9
    - DK650..... 10
    - DK750..... 11
  - Display Rear View ..... 12**
    - DK430 / DK550..... 12
    - DK650..... 12
    - DK750..... 13
  - Display Right View ..... 14**
    - DK430 / DK550..... 14
    - DK650..... 14
    - DK750..... 15
  - Display Left View..... 16**
    - DK650..... 16
    - DK750..... 17
  - Display Bottom View..... 18**
    - DK430 / DK550..... 18
    - DK650..... 19
    - DK750..... 19
  - OPS Module ..... 20**
  - Remote Control ..... 21**
    - Installing Batteries ..... 22
    - Remote Control Usage..... 22
- Installing the Wall Mount..... 23**
  - DK430 / DK550..... 23
  - DK650 / DK750..... 26
- Installing the OPS Module..... 29**
- Connections ..... 31**
  - HDMI In..... 31

- DisplayPort In ..... 31**
- VGA In ..... 32**
- DVI-D In ..... 32**
- Audio In / PC-Audio ..... 33**
  - NovoDisplay ..... 33
  - OPS Module ..... 33
- LAN (RJ-45)..... 33**
  - OPS Module ..... 33
- RS-232 In..... 34**
  - NovoDisplay ..... 34
  - OPS Module ..... 34
- USB (2.0)..... 34**
  - NovoDisplay ..... 34
  - OPS Module ..... 34
- USB Type C (OPS Module only)..... 35**
- microSD (OPS Module only)..... 35**
- DVI-D Out ..... 36**
- RS-232 Out..... 36**
- Audio Out..... 37**
- Getting Started ..... 38**
  - Powering the Display ..... 38**
  - Switching Input Source ..... 39**
  - Setting up an Internet Connection..... 40**
    - Setting up a Wi-Fi Connection..... 41
  - Display Settings ..... 44**
    - Picture ..... 45
    - Sound ..... 46
    - Settings..... 47
- Cleaning the Display..... 48**
- Specifications..... 49**
- Troubleshooting..... 50**
- Appendix (RS-232 Specifications)..... 51**
- Copyright Statement..... 52**

# Safety

## Placement

- Do not place the unit on an unstable cart, stand, tripod, bracket, table, or shelf.
- Do not expose the unit to direct sunlight and other sources of heat.
- Do not put the unit near appliances that generate magnetic fields.
- Do not put any liquid near or on the unit, make sure you do not spill any liquid inside the unit.
- Do not put heavy objects on top of the unit.

## Power Supply

- Check that the unit's operating voltage is identical to your local power supply.
- Please unplug the display from the power supply during possible thunder-storms or lightning.
- Please unplug the display from the power supply when the unit will be idle for a long time.
- Please prevent the power cable from receiving physical or mechanical damage.
- Please use the original power cable from the product packaging, and don't modify or lengthen it.
- Please check and ensure that the AC source is connected with the ground.
- The power cable that comes with the display is for use exclusively by this device.

## LED Screen

- This display only supports landscape display orientation. Do not mount in portrait display orientation or mount facing up or facing down.
- Never use any hard or sharp object in place of the styluses.
- Do not use permanent or dry-erase markers on the screen. If dry-erase markers are used on the screen, remove the ink as soon as possible with a lint-free, non-abrasive cloth.
- Unplug the power cable before cleaning.
- For a longer panel lifetime and better display performance, do not set the display to high brightness for a long period of time.

## Temperature

- Do not place the unit near or over a radiator or a heater.
- If your display is suddenly moved from a cold to a warm place, please unplug the power cable and do not turn it on at least 2 hours, making sure the moisture inside the unit is all evaporated.
- Normal operating temperature is 0 - 40°C (32°F - 104°F).

## Humidity

- Do not expose the unit to rain, or place in a high humidity area.
- Please make sure indoor environment is dry and cool.
- Normal operating humidity is 10% - 90% to 20% - 85%.

## Ventilation

- Please put the unit in a well ventilated place, so the heating can be released easily.
- Ensure that the unit has enough space for ventilation. Space requirement: left, right and back >10cm, top > 20cm.

## Earphone

- Using the earphones to listen to loud audio for an extended period of time might affect one's hearing.
- Before using earphones, please turn down the volume in advance.

## Battery

- Please make sure the battery is properly disposed or recycled after use.
- Please keep the battery away from children.
- DO NOT throw the battery into a fire.
- For the remote control batteries, ensure that the correct batteries are used and installed in the proper orientation.

## Maintenance

- This machine should only be maintained/serviced by certified technician.
- Inspect the display mount frequently to ensure that it has remained securely installed.
- Check the mounting location for loose screws, gaps, distortions, signs of damage or weakness that can occur over time.

## Disposal of Old Electric and Electronic Equipment



The symbol on your product or the package represents that the product should not be treated as the normal household waste when discarded but should be carried to the recycling location of the waste electric and electronic equipment. The consequence on the environment and human health due to the incorrect disposal of the product can be prevented if it can be ensured that the product is properly discarded. Material recycling is helpful to the protection of natural resources. The symbol is only valid in European Union. If you want to discard electrical and electronic equipment, contact the governmental authorities or your dealer for the correct method of disposal.

## Important Recycling Instructions

The product may contain other electronic wastes and may pose risk if not discarded properly. Abide by the local, state/provincial or federal laws of recycling or discarding. For more information, please visit the website and contact Electronic Industries Alliance (EIA) on [WWW.EIAE.ORG](http://WWW.EIAE.ORG).

## Regulatory Compliance

### FCC Warning

This equipment has been tested and found to comply with the limits for a Class A digital device pursuant to Part 15 of the FCC Rules. These limits are designed to provide reasonable protection against harmful interference when the equipment is operated in a commercial environment.

This equipment generates, uses, and can radiate radio frequency energy and, if not installed and used in accordance with the instruction manual, may cause harmful interference to radio communications. Operation of this equipment in a residential area is likely to cause harmful interference in which case the user will be required to correct the interference at his/her own expense.

Changes or modifications not expressly approved by the parties responsible for compliance could void the user's authority to operate the equipment.

### Federal Communications Commission (FCC) Notice (U.S. Only)

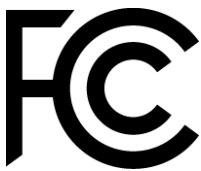

This device complies with Part 15 of the FCC Rules. Operation is subject to the following two conditions: (1) this device may not cause harmful interference, and (2) this device must accept any interference received, including interference that may cause undesired operation.

### Canada

This class A digital apparatus complies with Canadian ICES-003.

### CE Declaration of Conformity

This device complies with the requirements set out in the Council Directive on the Approximation of the Laws of the Member States relating to Electromagnetic Compatibility (2014/30/EU), Low-voltage Directive (2014/35/EU) and RoHS directive (2011/65/EU).

This product has been tested and found to comply with the harmonized standards for Information Technology Equipment, these harmonized standards published under Directives of Official Journal of the European Union.

**WARNING:** This equipment is compliant with Class A of EN55032/CISPR 32. In a residential environment this equipment may cause radio interference.

**NOTE:** This equipment has been tested and found to comply with the limits for a Class A digital device, pursuant to part 15 of the FCC Rules. These limits are designed to provide reasonable protection against harmful interference when the equipment is operated in a commercial environment. This equipment generates, uses, and can radiate radio frequency energy and, if not installed and used in accordance with the instruction manual, may cause harmful interference to radio communications. Operation of this equipment in a residential area is likely to cause harmful interference in which case the user will be required to correct the interference at his own expense.

### **Safety Certifications**

FCC-A, CE, CB, RoHS

### **Disposal and Recycling**

This product may contain other electronic waste that can be hazardous if not disposed of properly. Recycle or dispose in accordance with local, state, or federal Laws. For more information, contact the Electronic Industries Alliance at [www.eiae.org](http://www.eiae.org).

# Package Contents

Ensure that all of the proper items are included with the display in the packaging. The items that should be included in the packaging are:

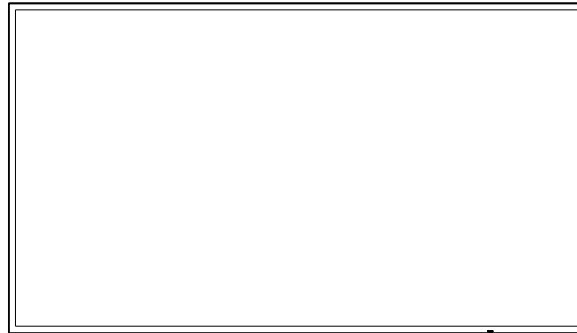

## NovoDisplay

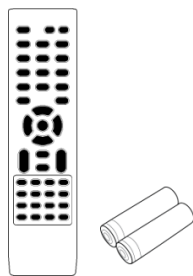

### Remote Control w/Battery

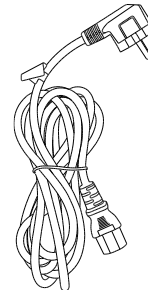

### Power Cable

For DK430 / DK550

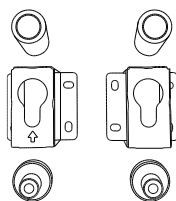

For DK650

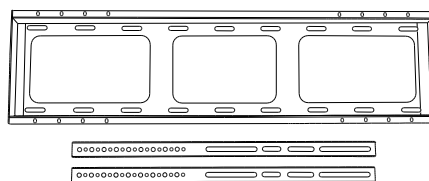

For DK750

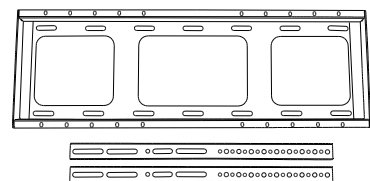

## Wall Mount Kit

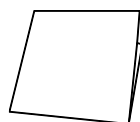

### Quick Start Guide

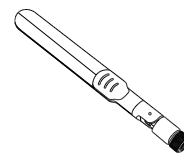

### Antenna x 2\*

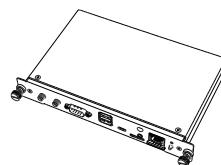

## OPS Module\*

*\*Item is included in a separate package.*



# Overview

## Display Front View

The following illustration shows the front side of the display and its various components:

### DK430 / DK550

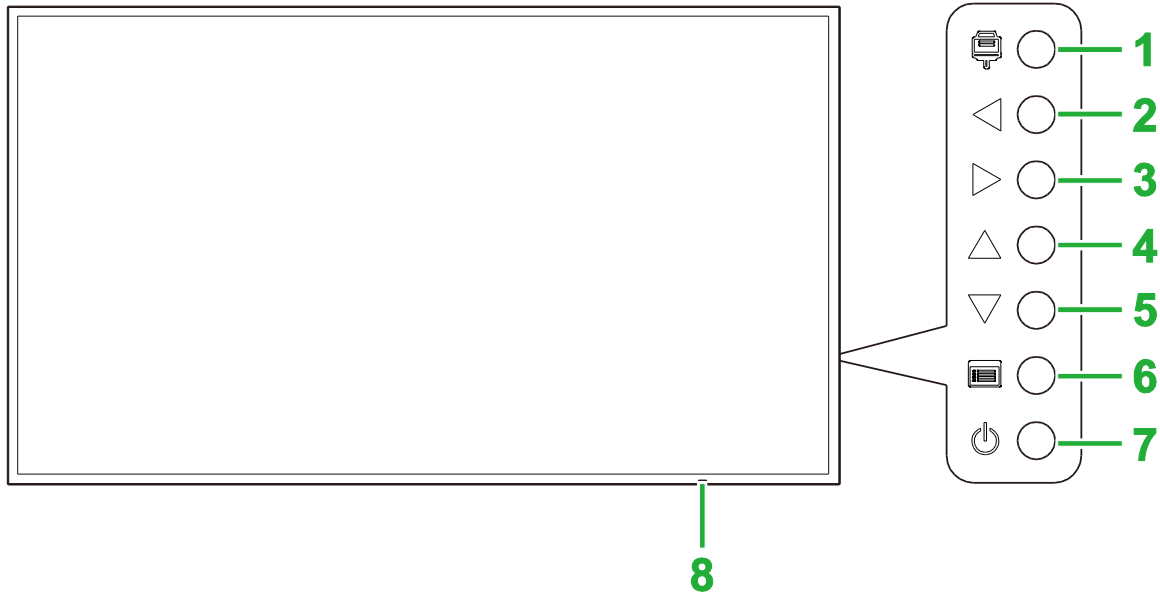

No.	Item	Description
1	Input Source Button	<ul style="list-style-type: none"> <li>Opens/Closes the input source menu for the display.</li> <li>Confirms menu item selections in the display's settings menu.</li> </ul>
2	Volume Down / Left Button	<ul style="list-style-type: none"> <li>Decreases the volume for the display.</li> <li>Switches sub-menus in the display's settings menu.</li> <li>Changes/Adjusts the settings for an item in the display's settings sub-menus.</li> </ul>
3	Volume Up / Right Button	<ul style="list-style-type: none"> <li>Increases the volume for the display.</li> <li>Switches sub-menus in the display's settings menu.</li> <li>Changes/Adjusts the settings for an item in the display's settings sub-menus.</li> </ul>
4	Up Button	Selects items in the display's setting sub-menus.
5	Down Button	Selects items in the display's setting sub-menus.
6	Menu Button	<ul style="list-style-type: none"> <li>Opens/Closes the display's settings menu.</li> <li>Returns to the previous menu in the display's settings sub-menus.</li> </ul>
7	Power Button	<ul style="list-style-type: none"> <li>[When display is off]: Press to power on the display.</li> <li>[When display is on]: Press to place the display on standby.</li> </ul>
8	Status Indicator LED	<ul style="list-style-type: none"> <li>Green: The display is powered on.</li> <li>Red: The display is in standby mode.</li> <li>Off: The display is not connected to a power source or the power switch is not turned on.</li> </ul>
	Remote Control IR Sensor	Receives the signal from the display's remote control with a range of up to 12 meters.

**DK650**

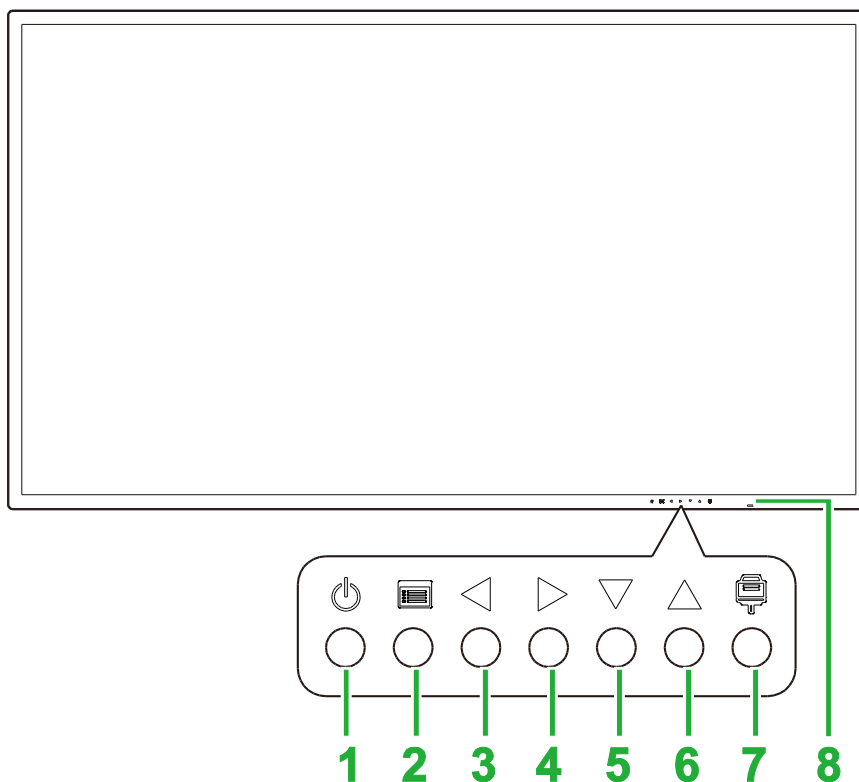

No.	Item	Description
1	Power Button	<ul style="list-style-type: none"> <li>• [When display is off]: Press to power on the display.</li> <li>• [When display is on]: Press to place the display on standby.</li> </ul>
2	Menu Button	<ul style="list-style-type: none"> <li>• Opens/Closes the display's settings menu.</li> <li>• Returns to the previous menu in the display's settings sub-menus.</li> </ul>
3	Volume Down / Left Button	<ul style="list-style-type: none"> <li>• Decreases the volume for the display.</li> <li>• Switches sub-menus in the display's settings menu.</li> <li>• Changes/Adjusts the settings for an item in the display's settings sub-menus.</li> </ul>
4	Volume Up / Right Button	<ul style="list-style-type: none"> <li>• Increases the volume for the display.</li> <li>• Switches sub-menus in the display's settings menu.</li> <li>• Changes/Adjusts the settings for an item in the display's settings sub-menus.</li> </ul>
5	Down Button	Selects items in the display's setting sub-menus.
6	Up Button	Selects items in the display's setting sub-menus.
7	Input Source Button	<ul style="list-style-type: none"> <li>• Opens/Closes the input source menu for the display.</li> <li>• Confirms menu item selections in the display's settings menu.</li> </ul>
8	Status Indicator LED	<ul style="list-style-type: none"> <li>• Green: The display is powered on.</li> <li>• Red: The display is in standby mode.</li> <li>• Off: The display is not connected to a power source or the power switch is not turned on.</li> </ul>
	Remote Control IR Sensor	Receives the signal from the display's remote control with a range of up to 12 meters.

**DK750**

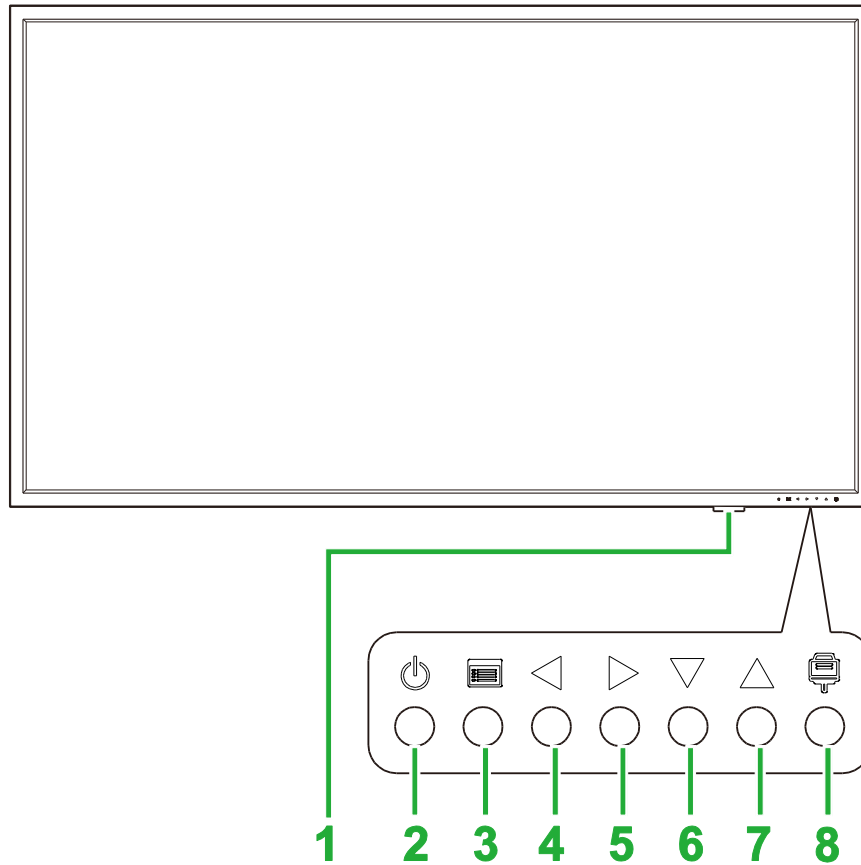

No.	Item	Description
1	Status Indicator LED	<ul style="list-style-type: none"> <li>Green: The display is powered on.</li> <li>Red: The display is in standby mode.</li> <li>Off: The display is not connected to a power source or the power switch is not turned on.</li> </ul>
	Remote Control IR Sensor	Receives the signal from the display's remote control with a range of up to 12 meters.
2	Power Button	<ul style="list-style-type: none"> <li>[When display is off]: Press to power on the display.</li> <li>[When display is on]: Press to place the display on standby.</li> </ul>
3	Menu Button	<ul style="list-style-type: none"> <li>Opens/Closes the display's settings menu.</li> <li>Returns to the previous menu in the display's settings sub-menus.</li> </ul>
4	Volume Down / Left Button	<ul style="list-style-type: none"> <li>Decreases the volume for the display.</li> <li>Switches sub-menus in the display's settings menu.</li> <li>Changes/Adjusts the settings for an item in the display's settings sub-menus.</li> </ul>
5	Volume Up / Right Button	<ul style="list-style-type: none"> <li>Increases the volume for the display.</li> <li>Switches sub-menus in the display's settings menu.</li> <li>Changes/Adjusts the settings for an item in the display's settings sub-menus.</li> </ul>
6	Down Button	Selects items in the display's setting sub-menus.
7	Up Button	Selects items in the display's setting sub-menus.
8	Input Source Button	<ul style="list-style-type: none"> <li>Opens/Closes the input source menu for the display.</li> <li>Confirms menu item selections in the display's settings menu.</li> </ul>

## Display Rear View

The following illustration shows the rear of the display and its various components:

### DK430 / DK550

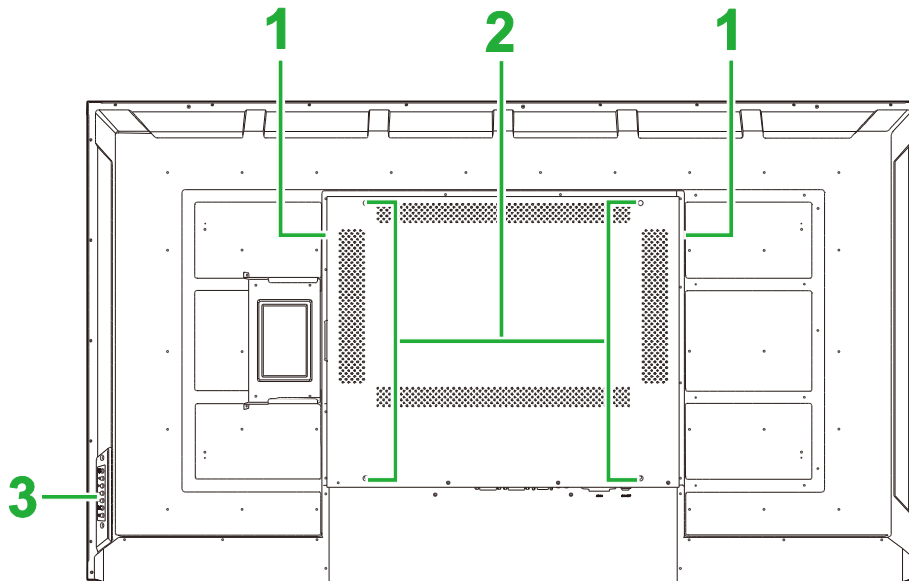

No.	Item	Description
1	Speakers	Broadcasts the display's audio.
2	Wall Mount Screw Holes	Used to install the wall mount included with the display. See the <b>"Installing the Wall Mount"</b> section for more information.
3	Control Panel	See the <b>"Display Front View"</b> section for more information on the control panel buttons.

### DK650

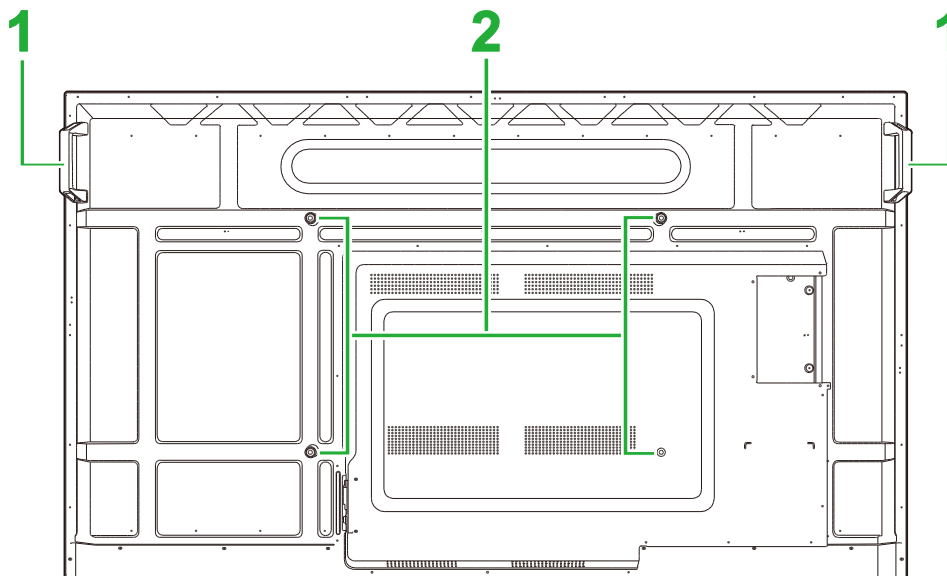

No.	Item	Description
1	Handles	Allows you to safely carry/move the display.
2	Wall Mount Screw Holes	Used to install the wall mount included with the display. See the <b>"Installing the Wall Mount"</b> section for more information.

DK750

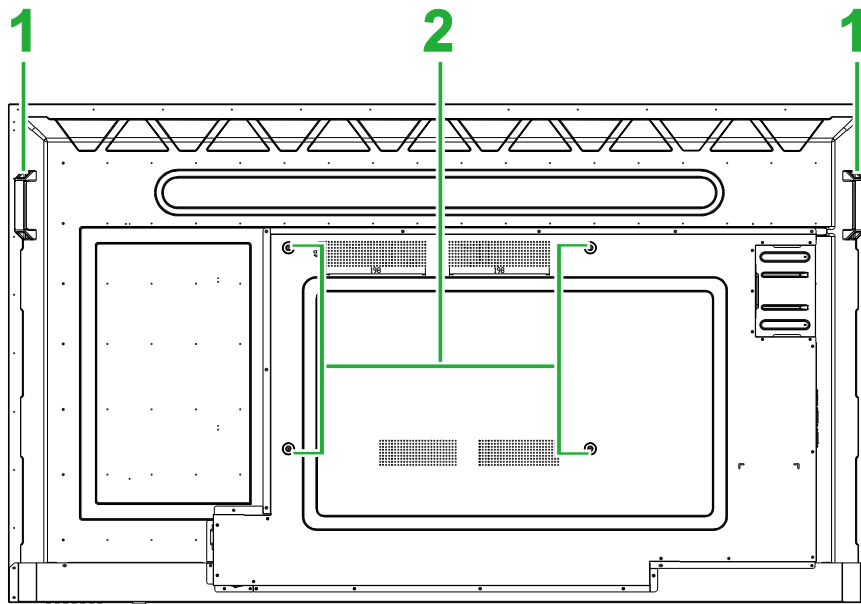

No.	Item	Description
1	Handles	Allows you to safely carry/move the display.
2	Wall Mount Screw Holes	Used to install the wall mount included with the display. See the <b>“Installing the Wall Mount”</b> section for more information.

## Display Right View

The following illustration shows the right side of the display and its various components:

### DK430 / DK550

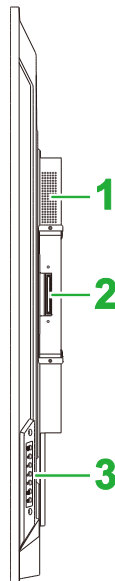

No.	Item	Description
1	Speaker	Broadcasts the display's audio.
2	OPS Slot	Remove the cover to install an OPS module to the display.
3	Control Panel	See the "Display Front View" section for more information on the control panel buttons.

### DK650

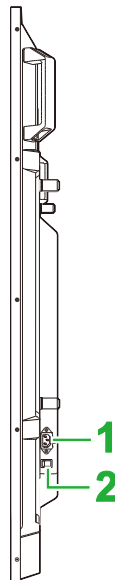

No.	Item	Description
1	Power Socket	Connects to a power outlet.
2	Power Switch	Activates the display once it is connected to a power source.

## DK750

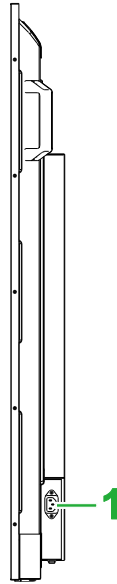

No.	Item	Description
1	Power Socket	Connects to a power outlet.

## Display Left View

The following illustration shows the left side of the display and its various components:

**NOTE:** The left side of DK430 and DK550 do not feature any major components.

### DK650

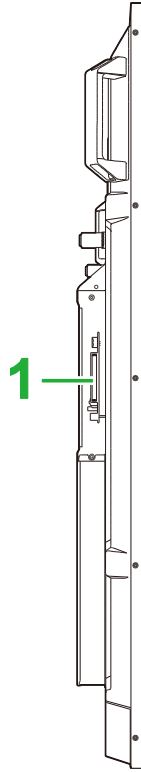

No.	Item	Description
1	OPS Slot	Remove the cover to install an OPS module to the display.



DK750

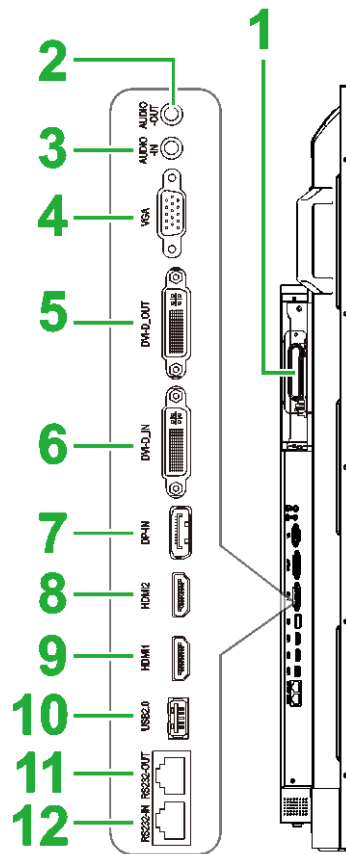

No.	Item	Description
1	OPS Slot	Remove the cover to install an OPS module to the display.
2	Audio Out Jack	Connects to external speakers to broadcast audio.
3	Audio In Jack	Connects to the video source to broadcast its audio.
4	VGA In Port	Connects to a computer to broadcast video.
5	DVI-D Out Port	Connects to a second display to transfer video broadcasts.
6	DVI-D In Port	Connects to a computer to broadcast video.
7	DisplayPort In Port	Connects to a computer to broadcast video and audio.
8	HDMI In Port 2 (2.0)	Connects to Blu-Ray/DVD players, set-top boxes, digital media players, computers, or other video sources to broadcast video and audio.
9	HDMI In Port 2 (2.0)	Connects to Blu-Ray/DVD players, set-top boxes, digital media players, computers, or other video sources to broadcast video and audio.
10	USB 2.0 Port	Connects to a USB flash drive to view media files or to a mouse/keyboard.
11	RS232 Out Port	Connects to a second display to transfer control commands.
12	RS232 In Port	Connects to a computer or server for control commands.

## Display Bottom View

The following illustration shows the bottom of the display and its various components:

### DK430 / DK550

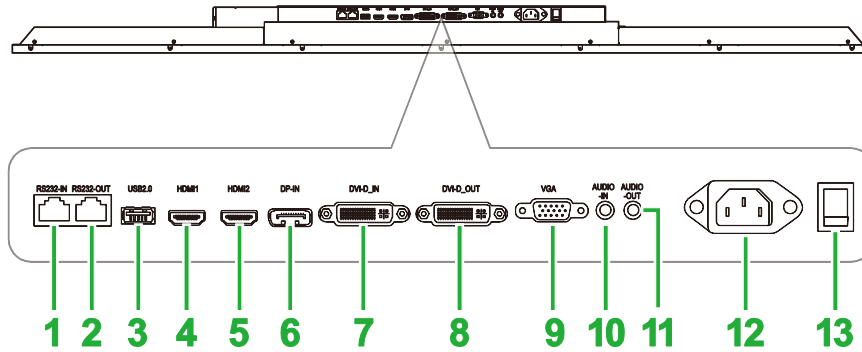

No.	Item	Description
1	RS232 In Port	Connects to a computer or server for control commands.
2	RS232 Out Port	Connects to a second display to transfer control commands.
3	USB 2.0 Port	Connects to a USB flash drive to view media files or to a mouse/keyboard.
4	HDMI In Port 1 (2.0)	Connects to Blu-Ray/DVD players, set-top boxes, digital media players, computers, or other video sources to broadcast video and audio.
5	HDMI In Port 2 (2.0)	Connects to Blu-Ray/DVD players, set-top boxes, digital media players, computers, or other video sources to broadcast video and audio.
6	DisplayPort In Port	Connects to a computer to broadcast video and audio.
7	DVI-D In Port	Connects to a computer to broadcast video.
8	DVI-D Out Port	Connects to a second display to transfer video broadcasts.
9	VGA In Port	Connects to a computer to broadcast video.
10	Audio In Jack	Connects to the video source to broadcast its audio.
11	Audio Out Jack	Connects to external speakers to broadcast audio.
12	Power Socket	Connects to a power outlet.
13	Power Switch	Activates the display once it is connected to a power source.

DK650

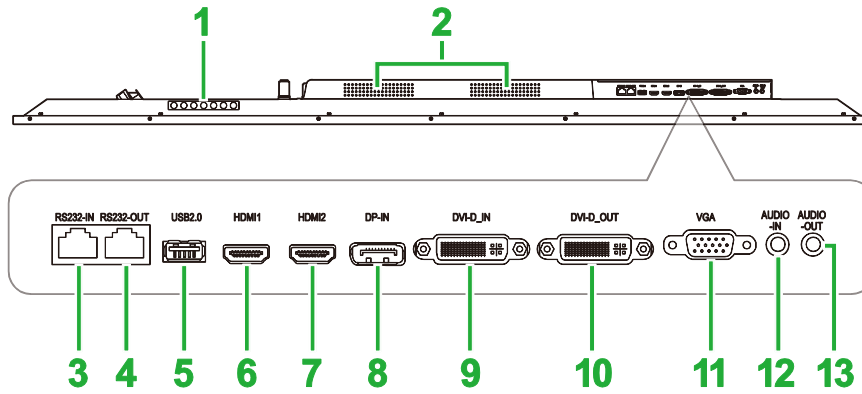

No.	Item	Description
1	Control Panel	See the “ <b>Display Front View</b> ” section for more information on the control panel buttons.
2	Speakers	Broadcasts the display’s audio.
3	RS232 In Port	Connects to a computer or server for control commands.
4	RS232 Out Port	Connects to a second display to transfer control commands.
5	USB 2.0 Port	Connects to a USB flash drive to view media files or to a mouse/keyboard.
6	HDMI In Port 1 (2.0)	Connects to Blu-Ray/DVD players, set-top boxes, digital media players, computers, or other video sources to broadcast video and audio.
7	HDMI In Port 2 (2.0)	Connects to Blu-Ray/DVD players, set-top boxes, digital media players, computers, or other video sources to broadcast video and audio.
8	DisplayPort In Port	Connects to a computer to broadcast video and audio.
9	DVI-D In Port	Connects to a computer to broadcast video.
10	DVI-D Out Port	Connects to a second display to transfer video broadcasts.
11	VGA In Port	Connects to a computer to broadcast video.
12	Audio In Jack	Connects to the video source to broadcast its audio.
13	Audio Out Jack	Connects to external speakers to broadcast audio.

DK750

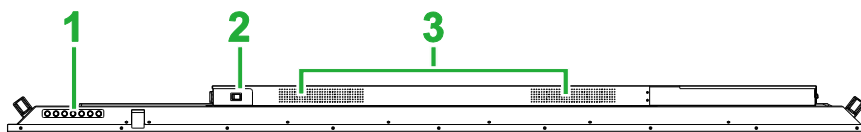

No.	Item	Description
1	Control Panel	See the “ <b>Display Front View</b> ” section for more information on the control panel buttons.
2	Power Switch	Activates the display once it is connected to a power source.
3	Speakers	Broadcasts the display’s audio.

## OPS Module

The following illustration shows the front of the OPS module and its various components:

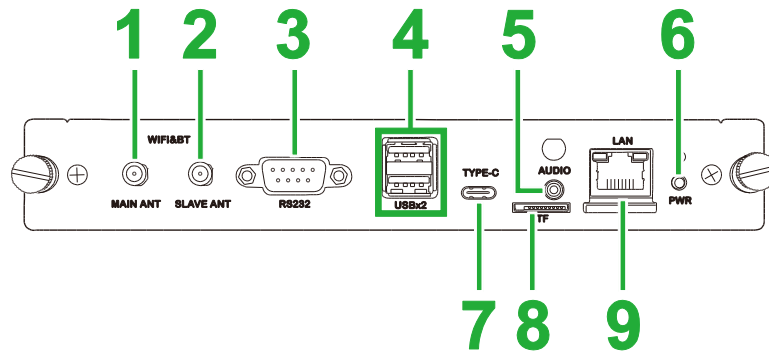

No.	Item	Description
1	Main Antenna Connector	Connect one of the supplied antennas to this connector.
2	Auxiliary Antenna Connector	Connect one of the supplied antennas to this connector.
3	RS232 In Port	Connects to a computer or server for control commands. <i>NOTE: The RS232 port on the OPS module does not support control commands, it is only used for debugging. To send control commands to the display, use the embedded RS232 In port on the display.</i>
4	USB 2.0 Ports	Connects to a USB flash drive to view media files or to a mouse/keyboard.
5	Audio In Jack	Connects to the video source to broadcast its audio.
6	Power Button	Deactivates the OPS module.
7	USB Type-C Port	Connect a mouse/keyboard or a USB Type-C flash drive to save app-related files.
8	microSD Card Slot	Reads files stored on a microSD card. <i>NOTE: The microSD card slot does not support playback of media files, it is only used for software upgrades and saving NovoDS playlists.</i>
9	LAN Port	Connects to a network router.

## Remote Control

The following illustration shows the display’s remote control and its buttons:

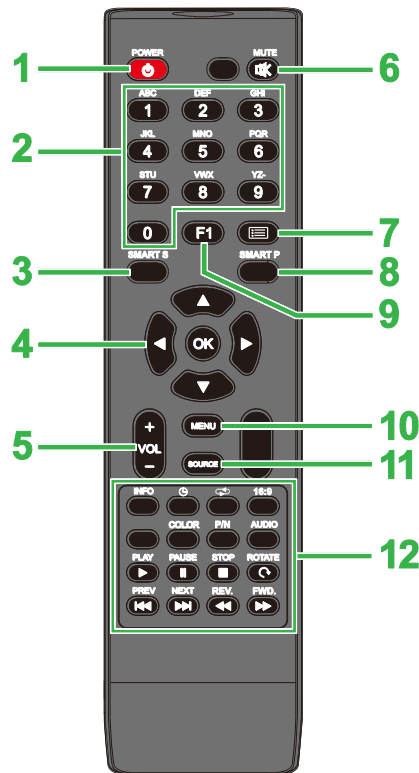

No.	Button	Description
1	Power	Turns the display on or off.
2	Numeric Keypad	Numeric input buttons.
3	Smart Sound	Switches sound mode.
4	Navigation Buttons	Navigates between various applications and menus shown on screen.
5	Volume +/-	Adjusts the display’s audio level.
6	Mute	Disables the display’s audio.
7	No Function	
8	Smart Picture	Switches picture mode.
9	Screen Freeze	Freezes the image on the screen.
10	Settings Menu	Opens the OSD settings menu.
11	Input Source	Opens the input source menu.
12	Function Buttons	INFO: Displays media information
		⌚: Toggles the sleep timer settings.
		↺: Toggles between repeat settings.
		16:9: Zooms the image.
		COLOR: Switches the color temperature.
		P/N: No function
		AUDIO: No function
		PLAY*: Plays the media file.
		PAUSE*: Pauses the media file.
		STOP*: Stops playback of the media file.
		ROTATE*: Rotates image.
		PREV*: Jumps to the previous media file.
		NEXT*: Jumps to the next media file
REV.*: Rewinds the playback of the media file.		
FWD*: Fast forwards the playback of the media file.		

\*Only functional for USB input sources.

### Installing Batteries

Before using the display's remote control you must first install the two AAA batteries included with the display.

1. Open the battery compartment cover on the remote control.

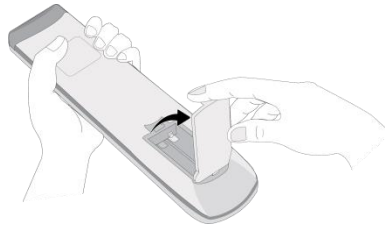

2. Insert the batteries ensuring that the + and - terminals on the battery match their corresponding terminals in the battery compartment.

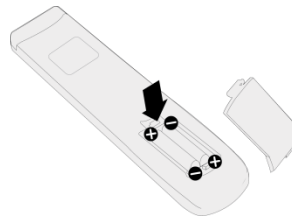

**!** *WARNING: Failure to install the correct batteries in the correct orientation may result in damage or possibly injury.*

3. Replace the battery compartment cover on the remote control.

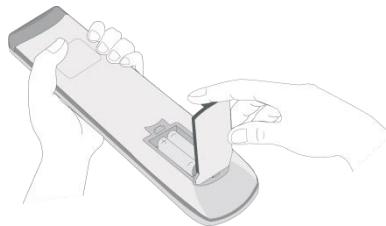

### Remote Control Usage

When using the remote control ensure that the remote control is pointed at the IR sensor at the front of the display within a range of 5 meters distance and 15-degrees to the left and right of the IR sensor.

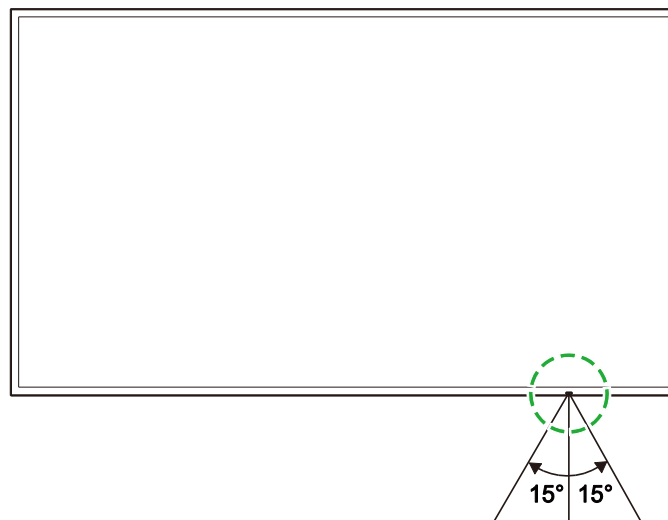

# Installing the Wall Mount

Before installing the wall mount ensure the following:

- Installation should only be done by a certified professional.
- The wall mounts are designed to bear only the weight of the displays. DO NOT place anything on the displays which might increase the weight of the displays.
- When setting the display down to install the wall mount, place it face down on a flat and stable surface covered by a protective sheet or cloth and a table cushion as shown in the illustration provided. DO NOT place the display on an uncovered surface.
- The display only supports landscape orientation. DO NOT mount the display in portrait orientation or so that it is facing up or down.



## DK430 / DK550

Ensure that all the following parts are included in the wall mount kit:

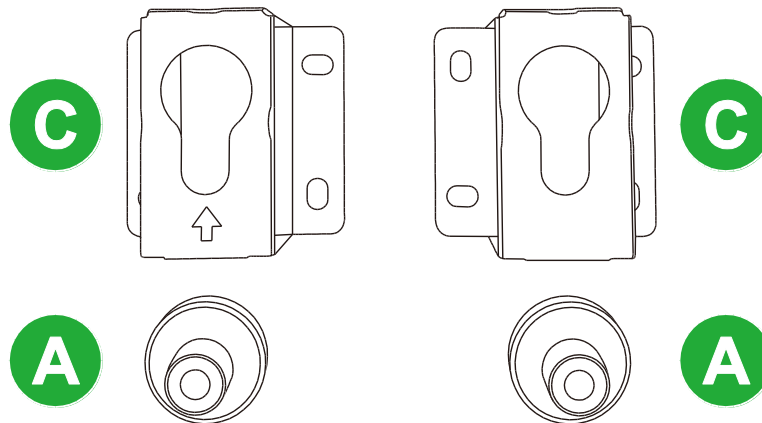

Letter	Item	Quantity
A	POM Nut	4
B	6x43mm Screws	4
C	U-Shaped Mount Brackets	2
D	6x50 Screws	8
E	4x43mm Screws	2

To mount NovoDisplay onto a wall follow the instructions below:

1. Place the four (A) POM nuts over the wall mount screw holes on the rear side of the display.

**NOTE:** If there are any screws or covers installed into the wall mount screw holes, remove them before placing the POM nuts over the screw holes.

2. Install the four (B) 5x43mm screws into the (A) POM nuts to secure them on the display. Measure and record the distance Y between the top two POM nuts.

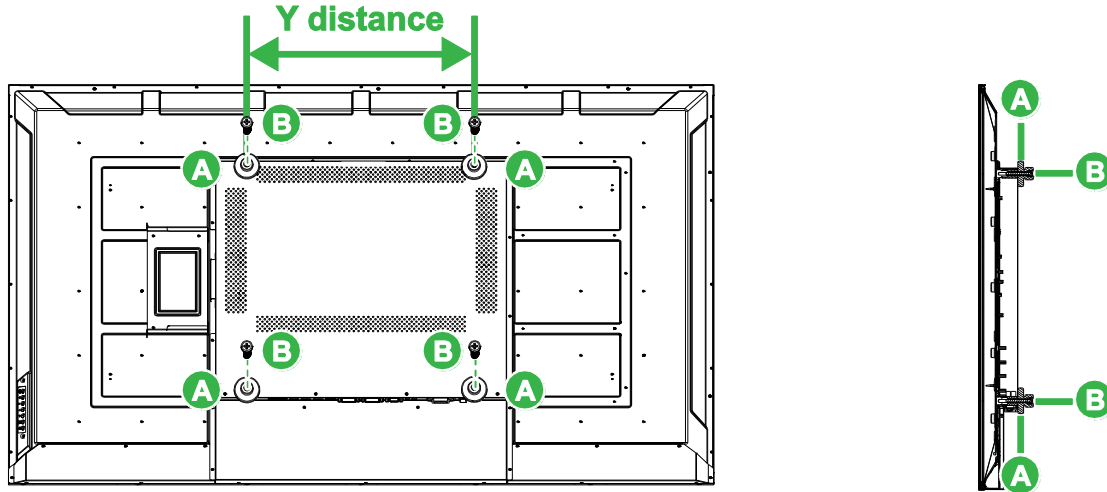

3. Place the two (C) U-shaped mount brackets in the correct position on the wall where you want mount the display on ensuring that the distance between the mount brackets are the same as the Y distance measured in step 2.

**CAUTION:** Use a levelling tool to ensure that the mount brackets are installed perfectly horizontal and vertical. If not the weight of the display will not be evenly distributed between the mount brackets which may cause the mount brackets to fall off.

4. Install the eight (D) 6x50mm screws into the mount brackets to secure them in place.

**NOTE:** If necessary, drill holes in the wall to ensure that the screws can be firmly secured to the wall.

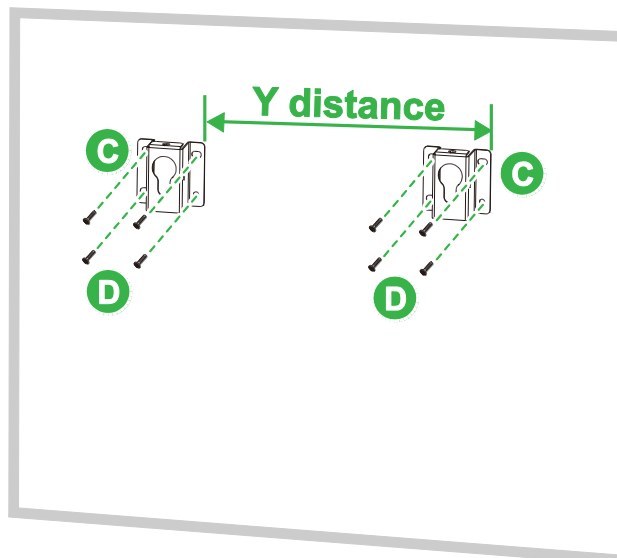



5. Hang the display on the wall so that the POM nuts on the display are installed into the mount brackets ensuring that they are properly secured.

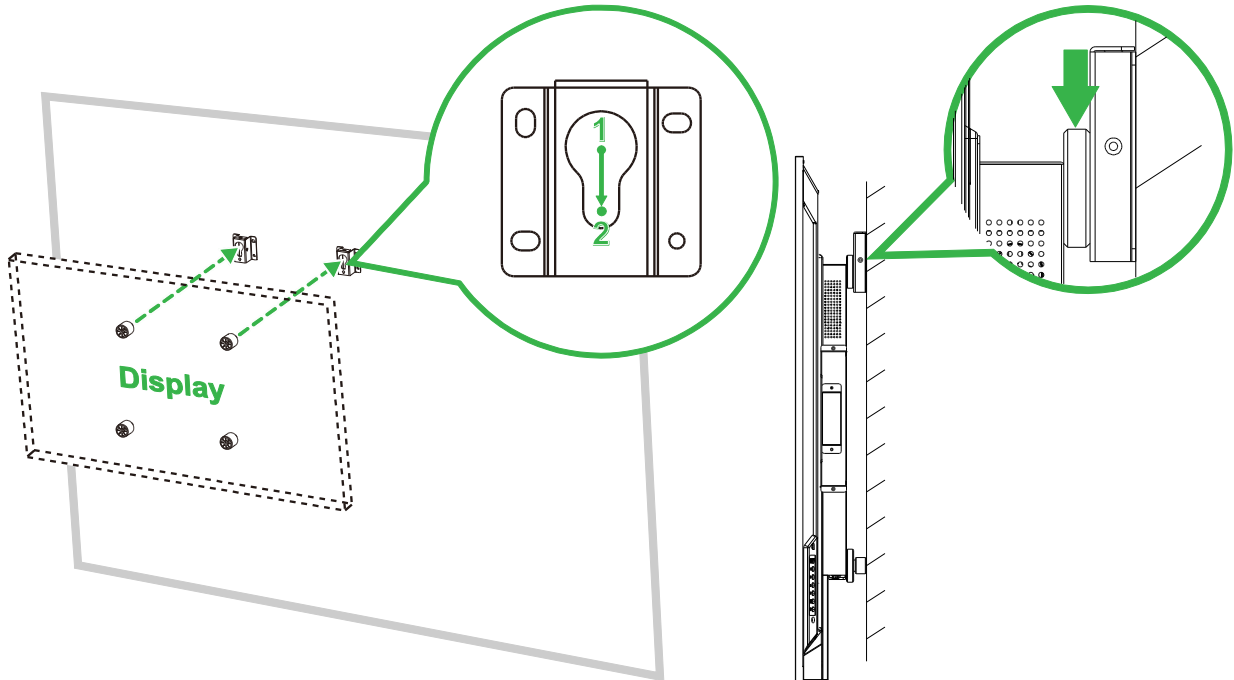

6. Install two (E) 4x43mm screws into either top or sides of the mount brackets to secure the POM nuts in place. Ensure that the display is firmly secure into the mount brackets before you release the display.

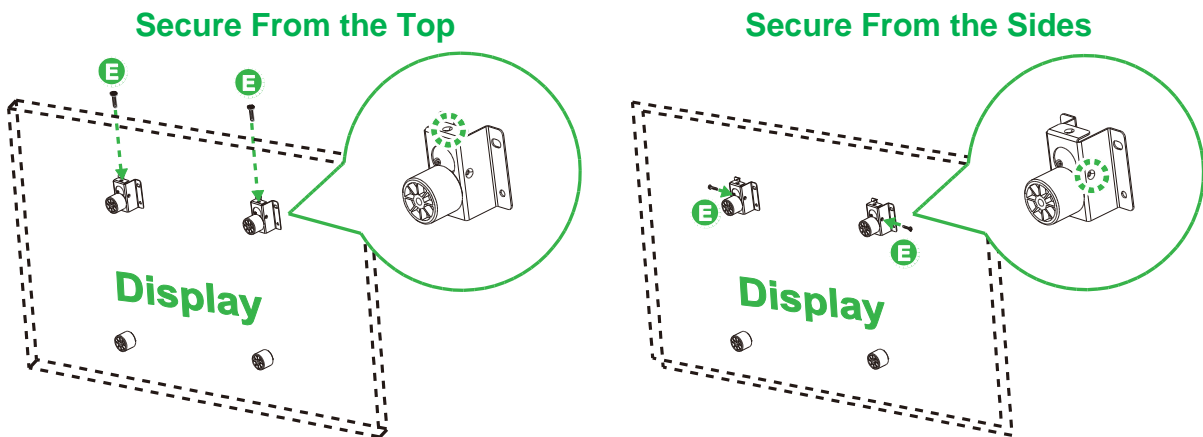

## DK650 / DK750

Ensure that all the following parts are included in the wall mount kit:

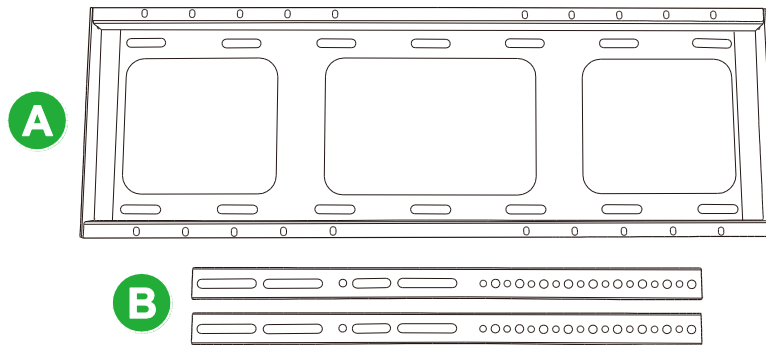

Letter	Item	Quantity
A	Horizontal Beam Bracket	1
B	Vertical Beam Bracket	2
C	M8x80mm Expansion Screws (Blue Zinc Plated)	8
D	M4x10mm Round Head Machine Screws with Spring Washers (Black Zinc Plated)	2
E	M5x100mm Screws	2

To mount NovoDisplay onto a wall follow the instructions below:

1. Install the two (E) M5x100mm screws into the (B) vertical beam brackets on the display with a depth of 2 - 10mm.

**NOTE:** DO NOT fully screw the M5x100mm screws into the bracket, only screw the screws with a depth of 2 - 10mm as a gap is needed between the ends of the screws and the top of the compartment in the bracket to firmly secure the display in the final step of this procedure.

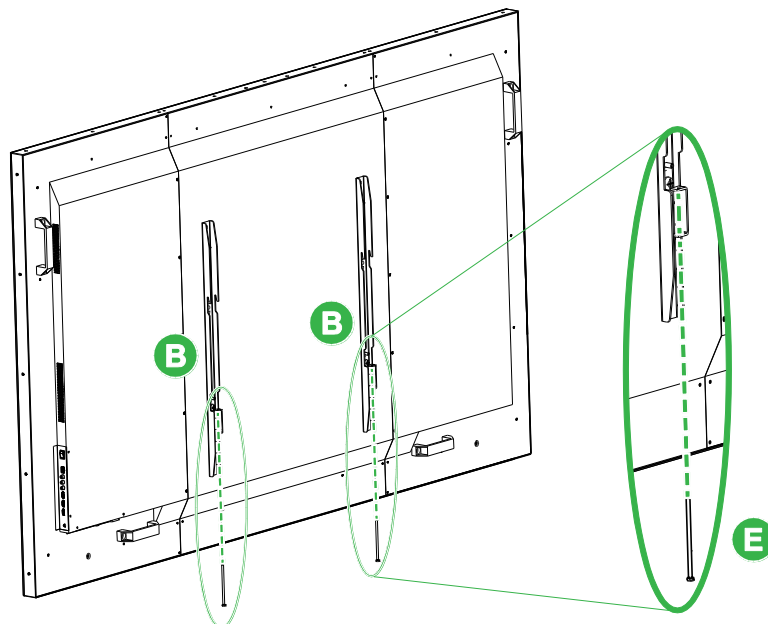

2. Place the (A) horizontal beam bracket up against the wall in the desired position and mark the screw locations on the wall so that there are four equally balanced screw locations on both the upper and lower parts of the bracket.

3. Use an impact drill to drill the holes in the marked position with a suggested depth of over 85mm.
4. Mount the (A) horizontal beam bracket onto the wall by placing the bracket against a proper wall and securing it using the eight (C) M8x80mm screws.

**NOTE:** You can choose the screw clearance depending on the conditions of the wall.

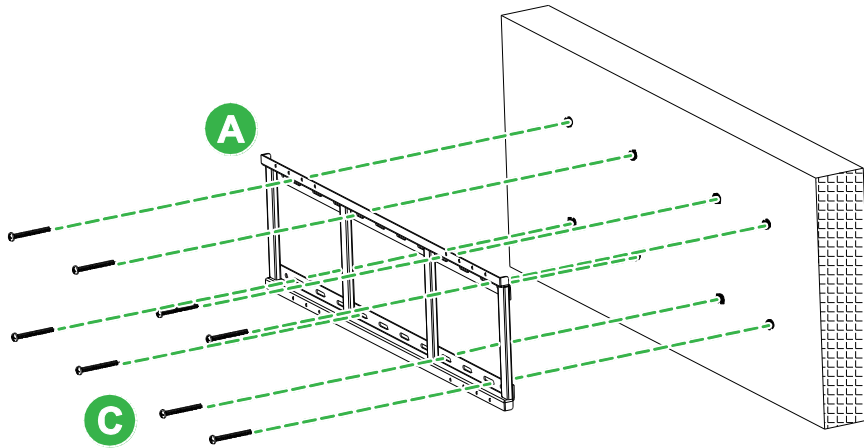

5. Mount the display (with the vertical beam brackets attached) onto the horizontal beam bracket on the wall so that the hooks on the upper part of the vertical beam brackets fit into the top section of the horizontal beam bracket.

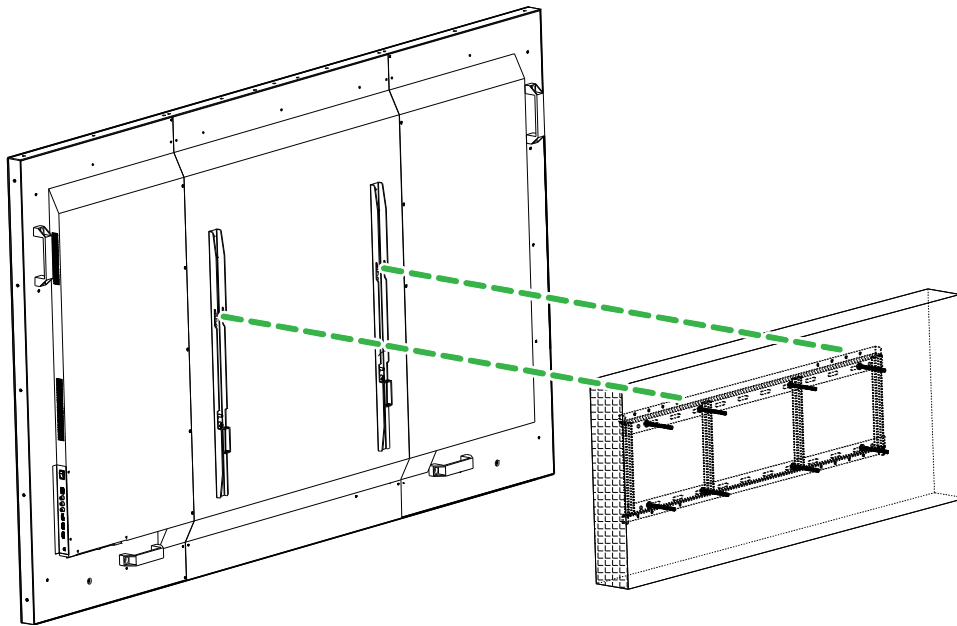

6. Tighten the (E) M5x100mm screws until they are fully screwed into the horizontal beam bracket.

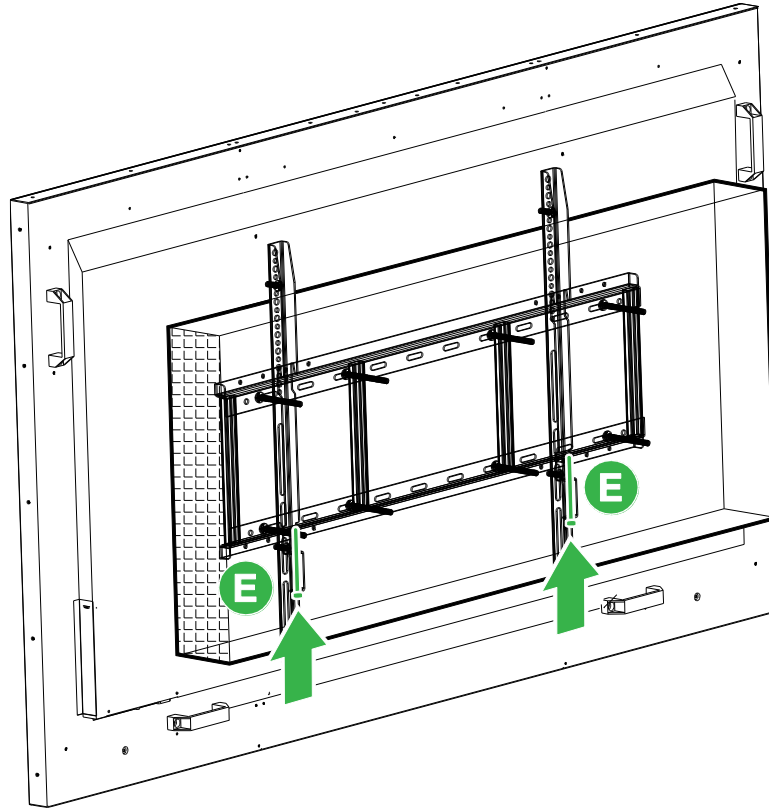

# Installing the OPS Module

Before you begin using the display it is suggested that you install the OPS Module first. If you do not install the OPS module before you begin using the display, the display will not have all the functions available for use. To install the OPS module follow the instructions below:

1. Remove the 2 screws securing the slot cover onto the display, and then remove the slot cover.

**DK430 / DK550**

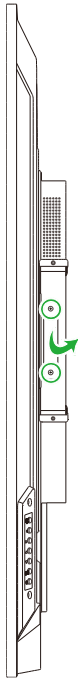

**DK650**



**DK750**

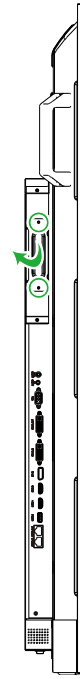

2. Slide the OPS module into the OPS slot.

**DK430 / DK550**

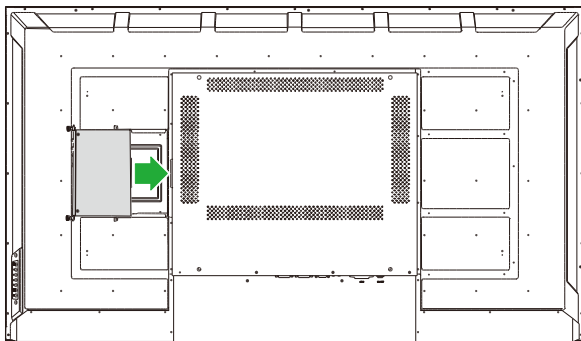

**DK650**

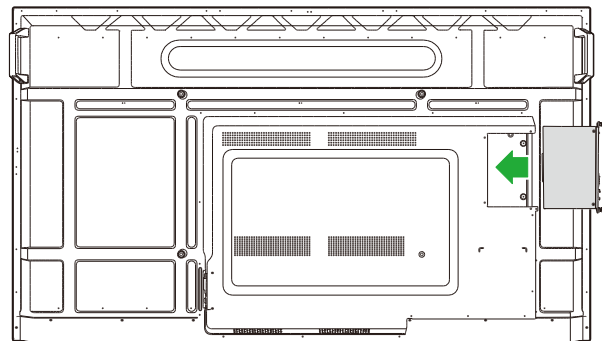

**DK750**

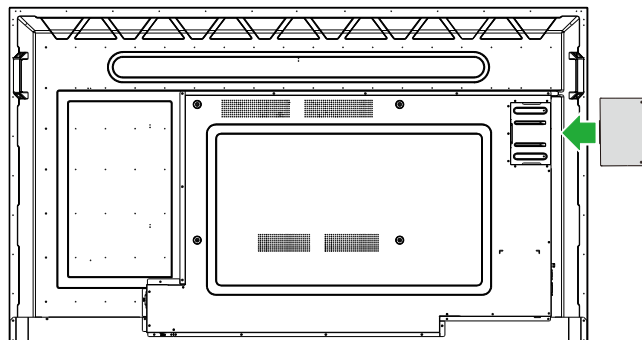

3. Tighten the two captive screws on the OPS module until the module is properly secure in the display.

**DK430 / DK550**

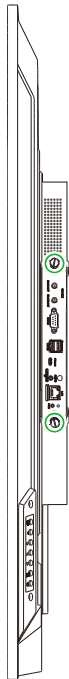

**DK650**



**DK750**

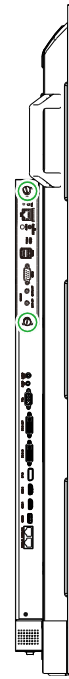

4. Install the antennas onto the connectors on the OPS module.

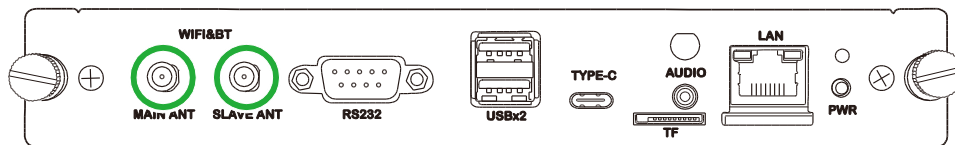

# Connections

This section describes the connections available for the various ports located on the sides of the NovoDisplay or the OPS module.

**NOTE:** It is suggested that you make any connections prior to powering on the display.

## HDMI In

The HDMI-In ports connects to various devices such as Blu-Ray/DVD players, set-top boxes, digital media players, computers, and other sources to broadcast video and audio on the NovoDisplay. When connecting a device to the HDMI-In port:

- Use an HDMI cable with a standard Type-A HDMI connector.
- Select the corresponding HDMI input in the input source menu on the NovoDisplay. See the Switching Input Source section for more information on selecting input sources.

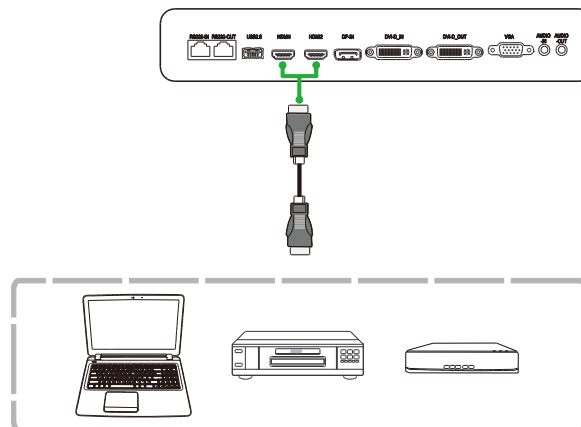

## DisplayPort In

The DisplayPort In port connects to computers to broadcast video and audio on the NovoDisplay. When connecting a computer to the Display In port:

- Use a standard DisplayPort cable.
- Select the DisplayPort input in the input source menu on the NovoDisplay. See the Switching Input Source section for more information on selecting input sources.

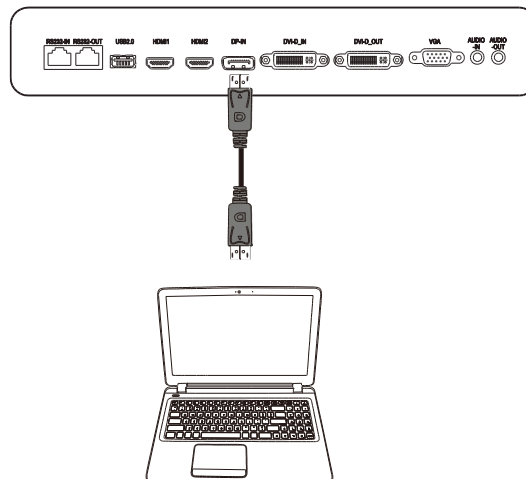

## VGA In

The VGA In port connects mainly to computers to broadcast video on the NovoDisplay. When connecting a device to the VGA In port:

- Use a standard VGA cable.
- Select the VGA input in the input source menu on the NovoDisplay. See the Switching Input Source section for more information on selecting input sources.
- If you want the NovoDisplay to also broadcast audio from the connected devices, connect an audio cable from the audio out jack of the source to the audio in jack of the NovoDisplay, as described in the Audio In / PC-Audio section below.

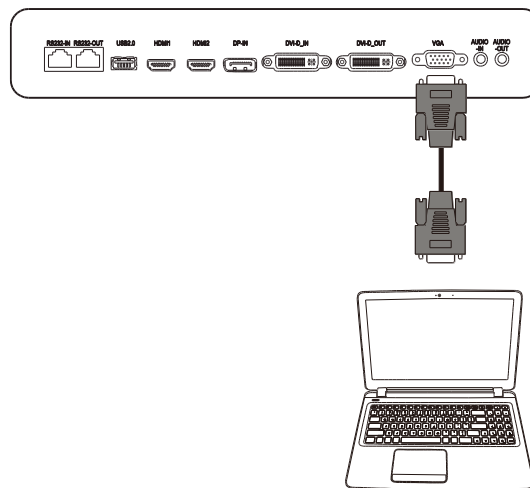

## DVI-D In

The DVI-D In port connects mainly to computers to broadcast video on the NovoDisplay. When connecting a device to the DVI-D In port:

- Use a standard DVI-D cable.
- Select the DVI-D input in the input source menu on the NovoDisplay. See the Switching Input Source section for more information on selecting input sources.
- If you want the NovoDisplay to also broadcast audio from the connected devices, connect an audio cable from the audio out jack of the source to the audio in jack of the NovoDisplay, as described in the Audio In / PC-Audio section below.

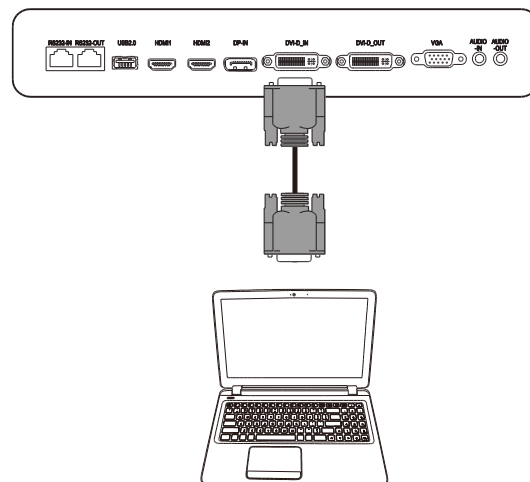



## Audio In / PC-Audio

The Audio In jack is used specifically for connections that feature video-only streams (such as a VGA connection) by connecting to the audio out jack of the video source to broadcast the audio from that source. When connecting a device to the Audio In port:

- Use a standard 3.5mm audio cable.

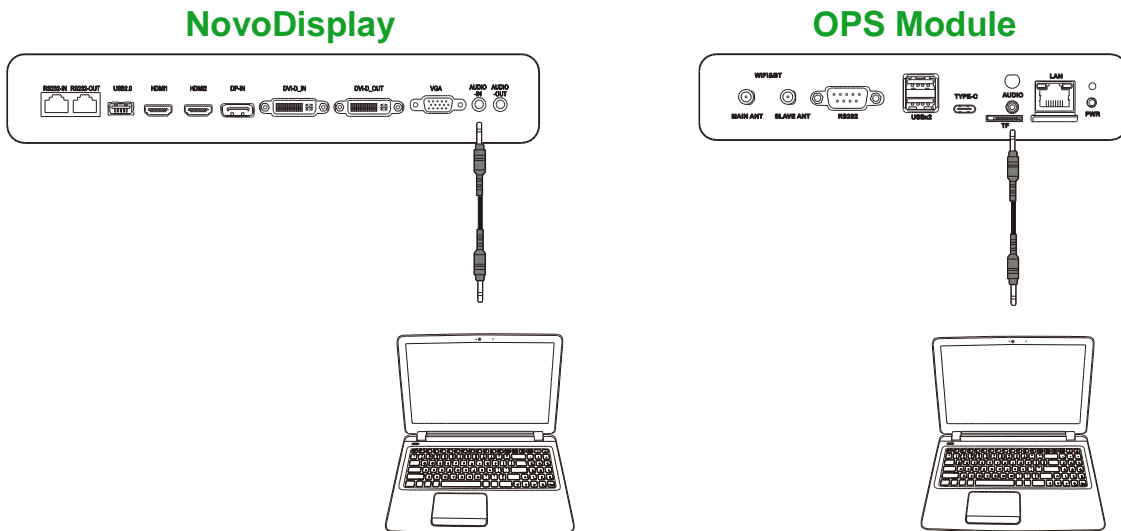

## LAN (RJ-45)

The LAN (RJ-45) port connects to a router or a hub to allow the NovoDisplay to access the internet. When connecting a router to the LAN port:

- Use a standard Ethernet cable.

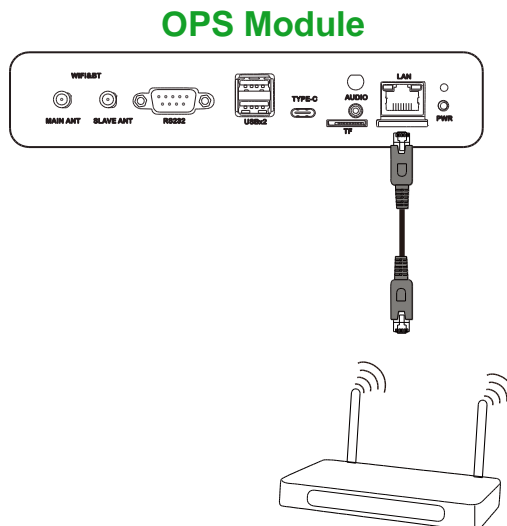

## RS-232 In

The RS-232 In port connects to a computer or server to provide data and control signals to the NovoDisplay. When connecting a device to the RS-232 port:

- For NovoDisplay: Use a standard Ethernet cable.
- For the OPS Module: Use a standard RS-232 cable.

**NOTE:** The RS232 port on the OPS module does not support control commands, it is only used for debugging. To send control commands to the display, use the embedded RS232 In port on the display.

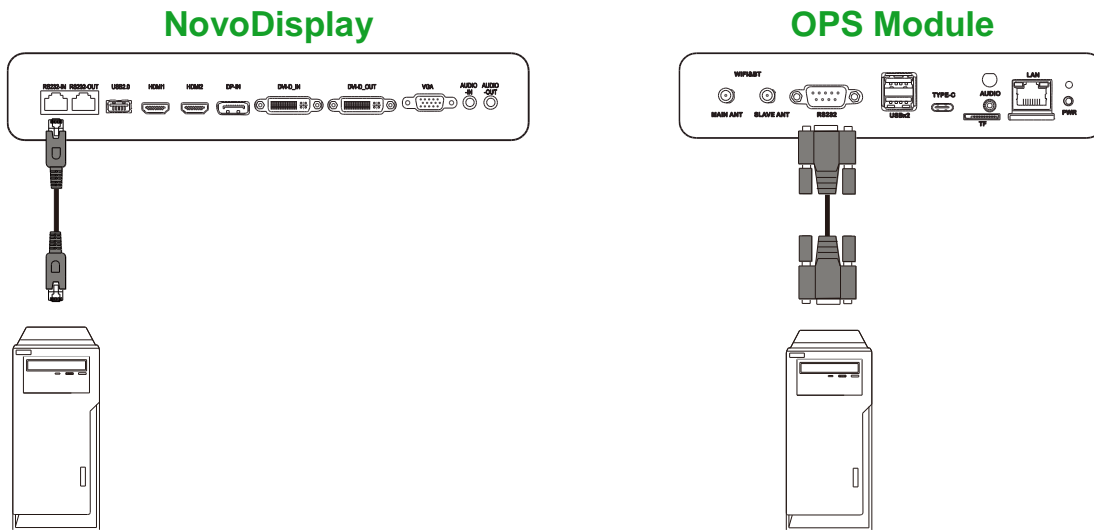

## USB (2.0)

The USB ports on both the NovoDisplay and OPS module allow you to connect USB devices such as a mouse or keyboard for easier navigation of the NovoDisplay’s interface, while the USB port on the OPS module also allows you to connect USB flash drives to save app related files. When connecting a USB flash drive:

- For USB Devices: Connect the device to the USB port on the display or OPS module.
- For USB Flash Drives: Connect the flash drive to the OPS module only.

**NOTE:** The USB Type-C ports do not support playback of media files.

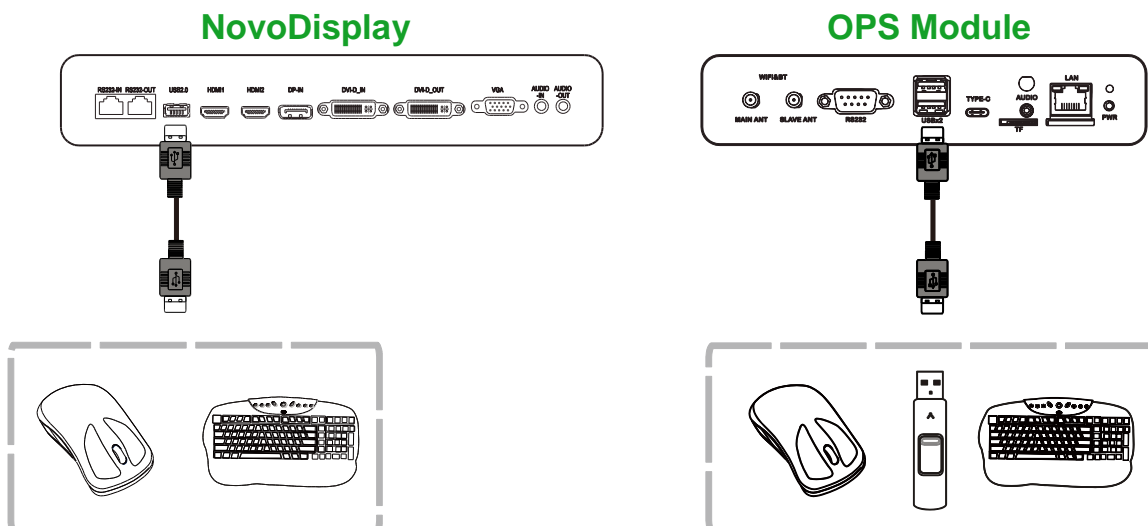

## USB Type C (OPS Module only)

The USB Type-C port allows you to connect USB devices or flash drives to save app-related files.

**NOTE:** The USB Type-C port is only used for USB devices and saving NovoDS playlists. It does not support playback of media files or direct video input sources.

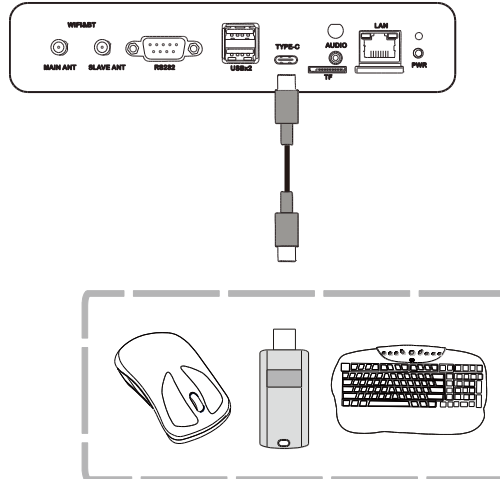

## microSD (OPS Module only)

The microSD card slot allows you to insert a microSD card to perform software upgrades or save app-related files.

**NOTE:** The microSD card slot is only used for software upgrades and saving NovoDS playlists. It does not support playback of media files.

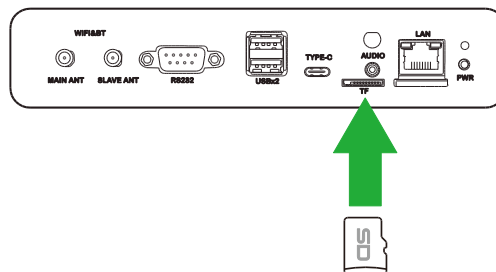

## DVI-D Out

The DVI-D Out port connects to another display in a daisy chain configuration to pass along the video signal derived from the DVI-D In port. When connecting another display to the DVI-D Out port:

- Use a standard DVI-D cable.
- Select the DVI input source on both displays and the video will be duplicated on both displays.

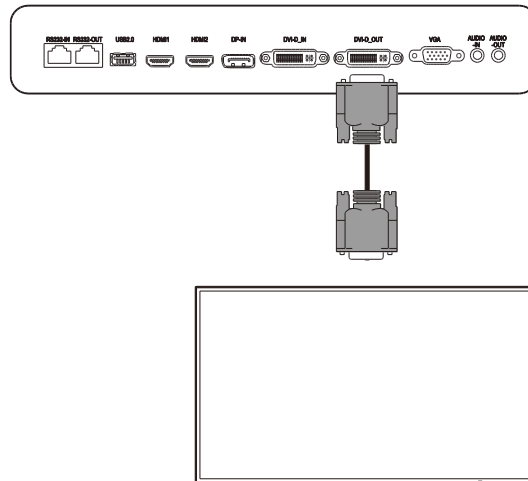

## RS-232 Out

The RS-232 Out port connects to another display in a daisy chain configuration to pass along the control commands derived from the RS-232 In port. When connecting another display to the RS-232 Out port:

- Use an Ethernet cable.

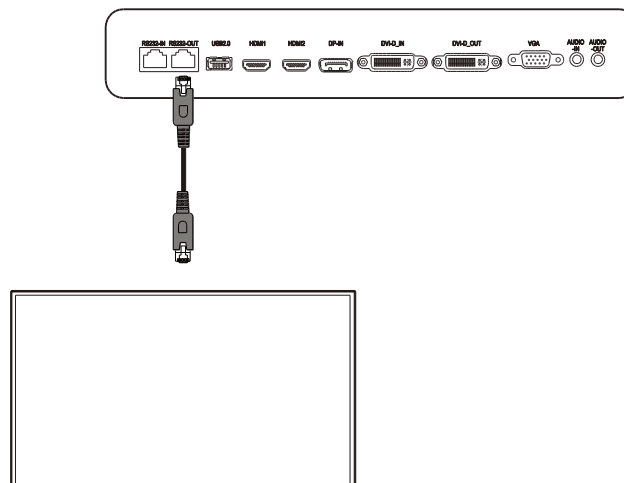

## Audio Out

The Audio-Out jack connects to external speakers to broadcast the audio from the NovoDisplay. When connecting external speakers to the Audio Out jack:

- Use a standard 3.5mm audio cable.

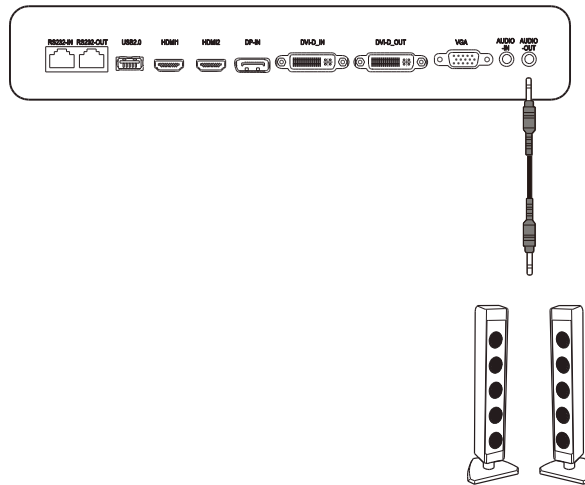

# Getting Started

## Powering the Display

After mounting/installing the NovoDisplay in the desired location you must supply power to the display using the following steps:

1. Plug the supplied power cable into the display and a power source.

**NOTE:** Only use the power cable provided in the packaging with the display.

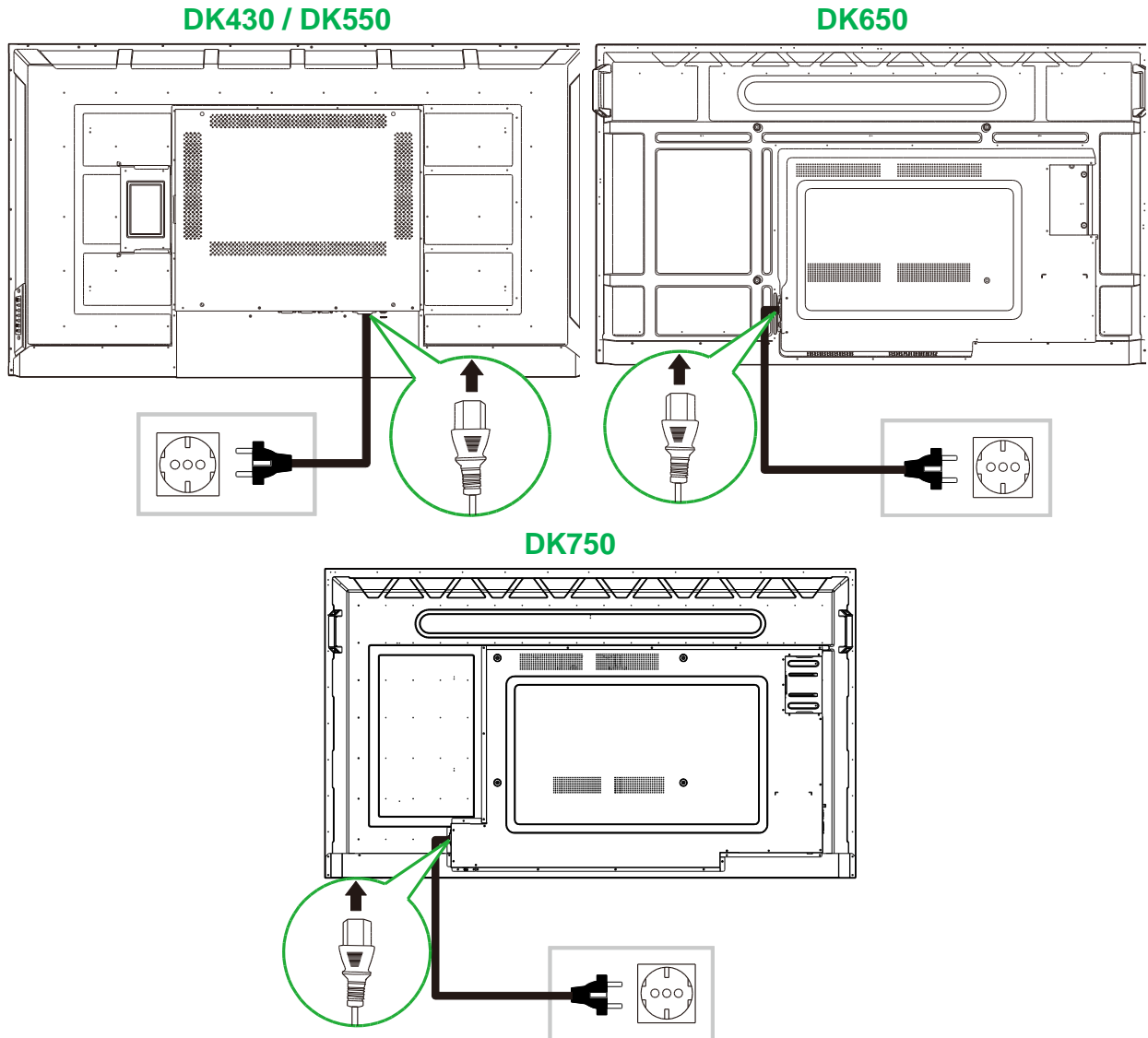

2. Turn the power switch located at the right side of the display on.

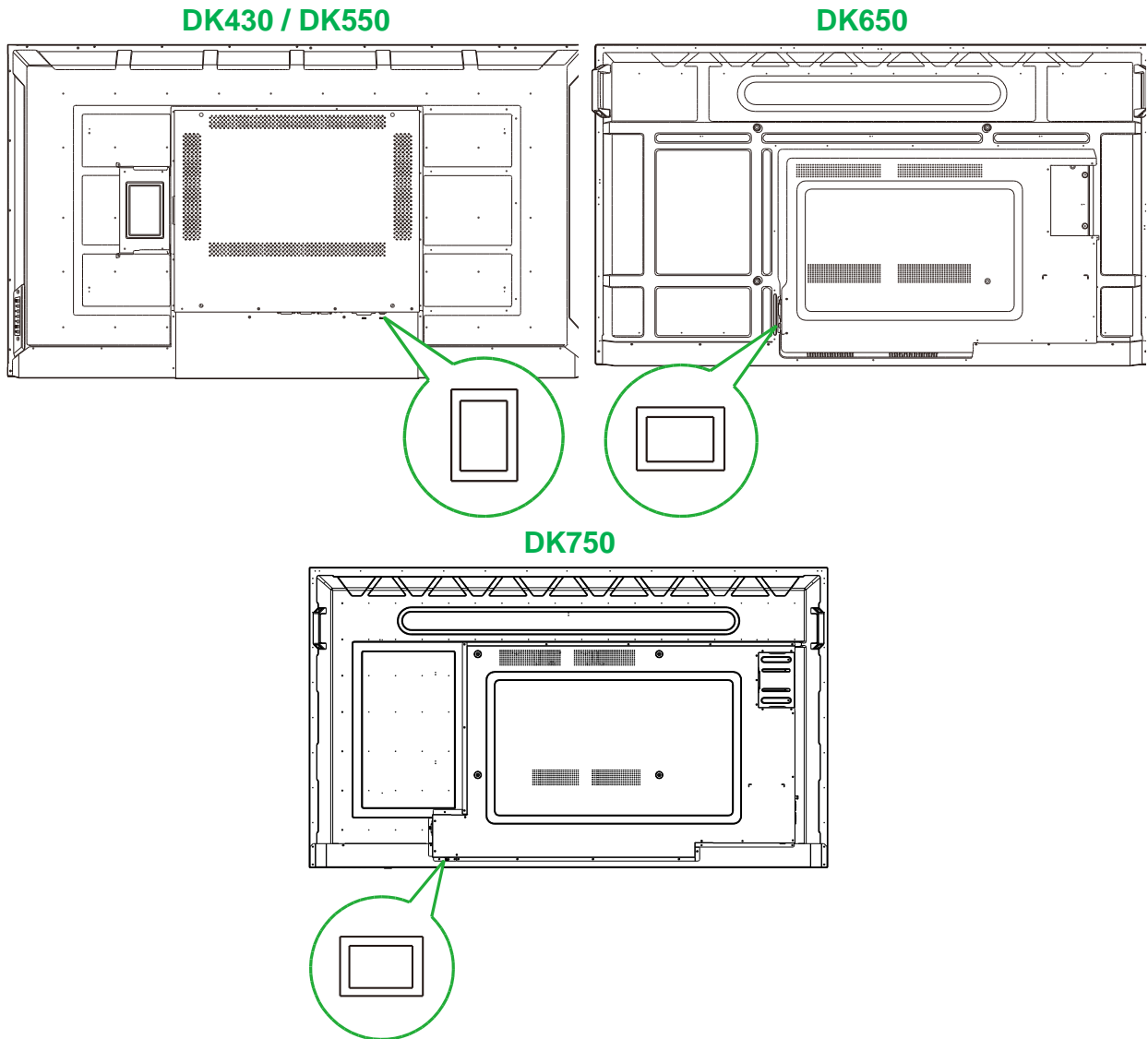

3. Press the power button on the display or the remote control to power on the display.

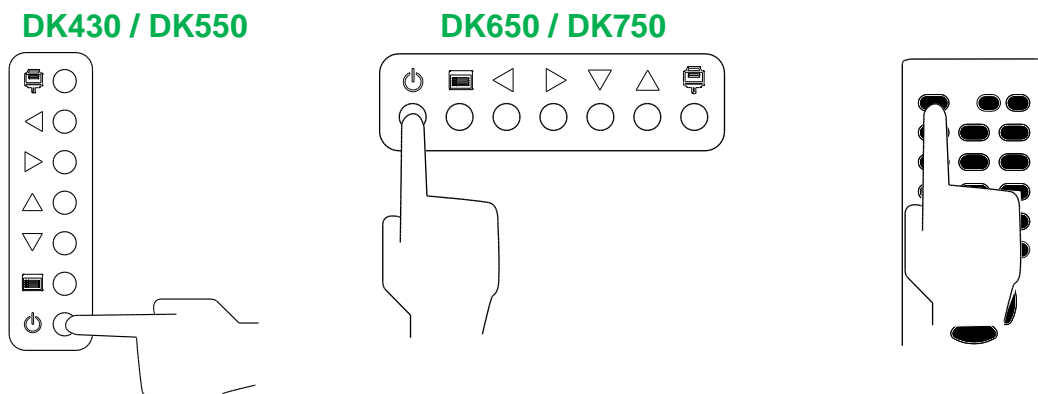

## Switching Input Source

After making a video input connection, open the input source menu to select which input source to show on the display. To open the input source menu choose one of the following methods:

- Press the input source (📺) button on the display.

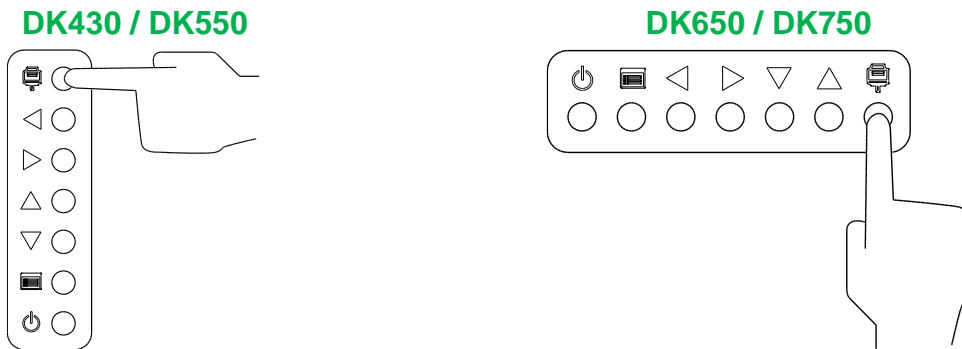

- Press the **SOURCE** button on the remote control.

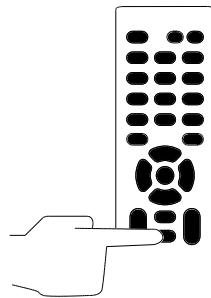

Once the input source menu is open use the up (▲) or down (▼) button on either the display or the remote control to select the video input you want to show on the display, and then press the menu (☰) button on the display or the **OK** button on the remote control to confirm your selection.

INPUT SOURCE
HDMI1
HDMI2
OPS
DVI
DP
VGA

**NOTE:** The OPS selection in the input source menu will only appear when the OPS module is installed in the display. See the *Installing the OPS Module* section for more information on installing the OPS module.

## Setting up an Internet Connection

NovoDisplay is able to connect to the internet using one of the following methods:



- A wired connection via the RJ-45 port, see the LAN (RJ-45) section for more information.
- A Wi-Fi connection.

## Setting up a Wi-Fi Connection

To set up a Wi-Fi connection:

1. Ensure that the OPS module is installed in the display. See the Installing the OPS Module section on page 29 for more information.
2. Open the input source menu and select **OPS**.

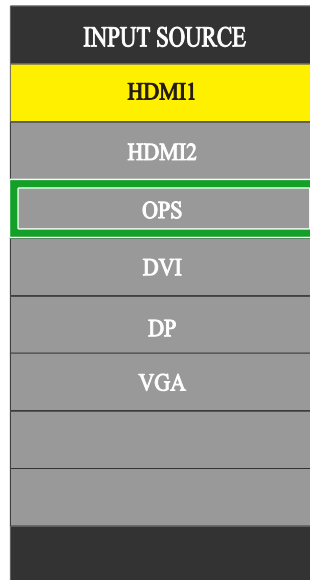

3. Select **Presentation > Settings** in the NovoDisplay home screen.

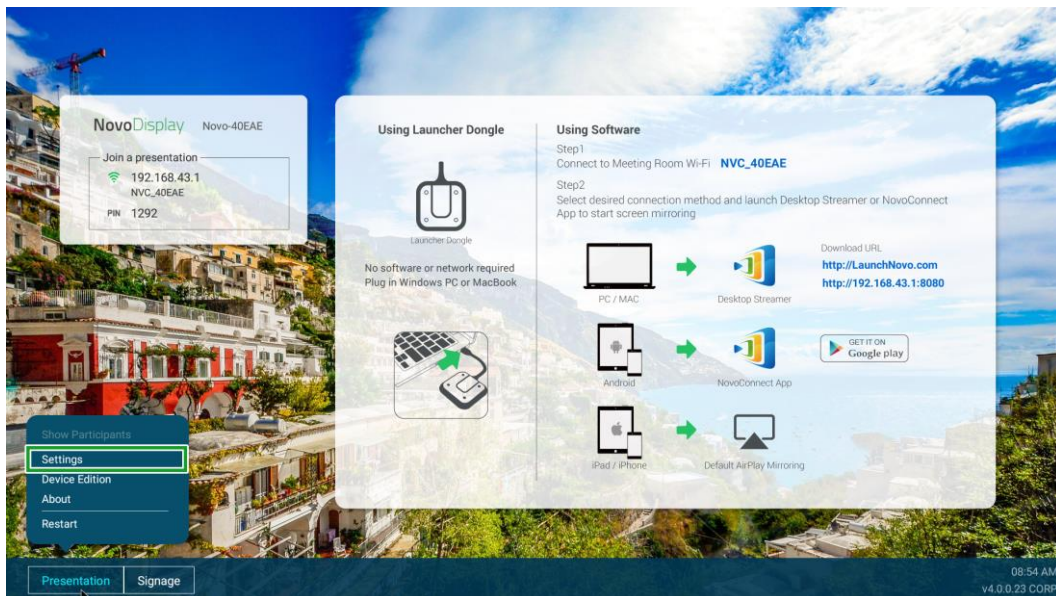

4. Select **Device Settings** in the **Settings** menu.

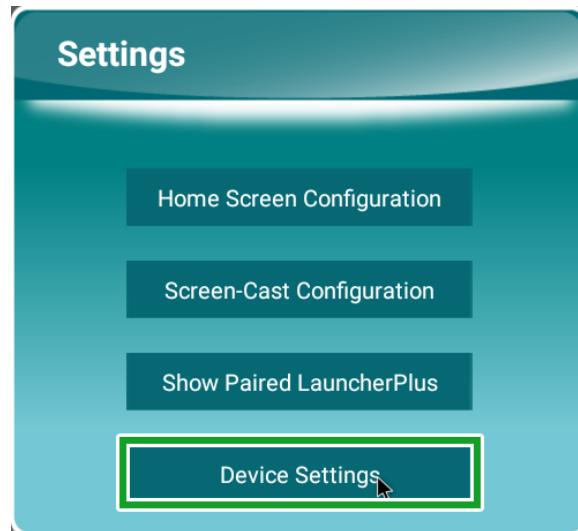

5. Select **Wi-Fi** in the **NT Settings** menu.

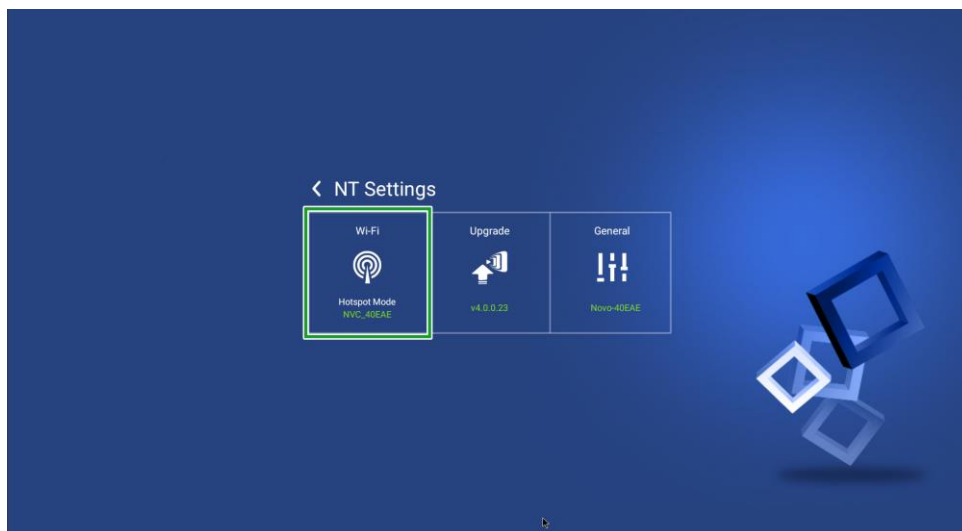

6. Select **Advanced** in the **General** menu.

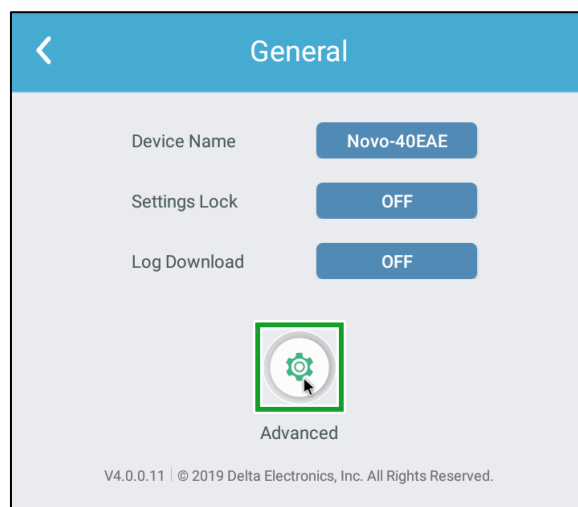

7. Select **Wi-Fi** in the **Settings** menu.

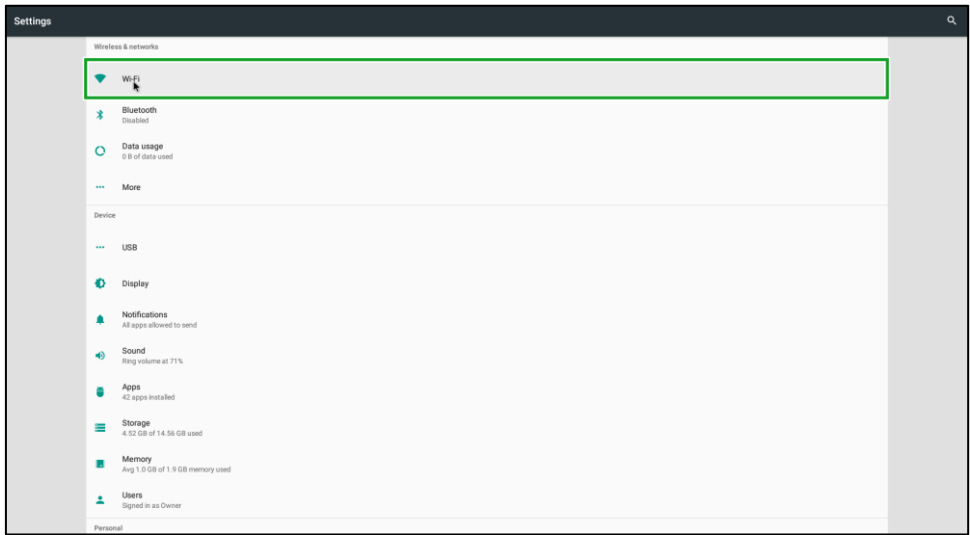

8. Turn the Wi-Fi switch on in the **Wi-Fi** menu.

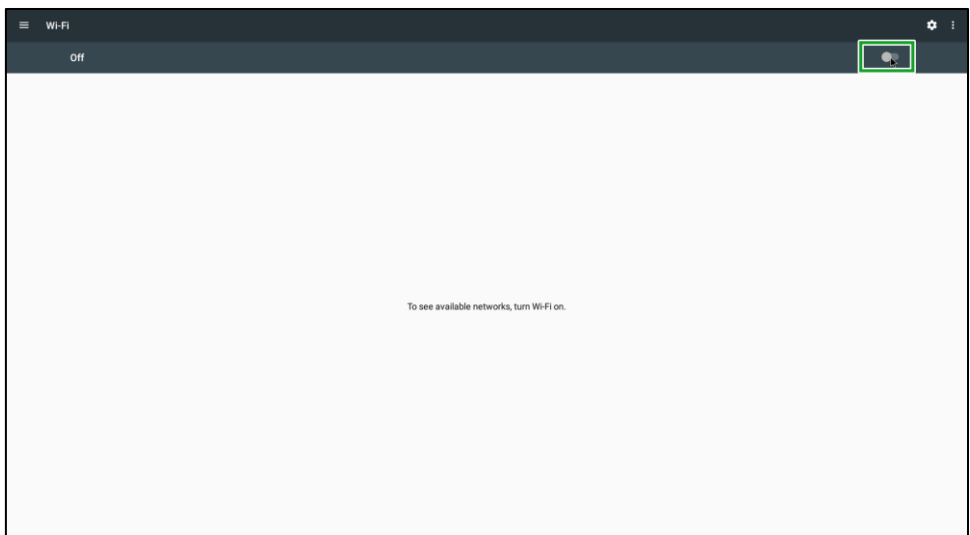

9. Select the Wi-Fi access point/router that you want NovoDisplay to connect to.

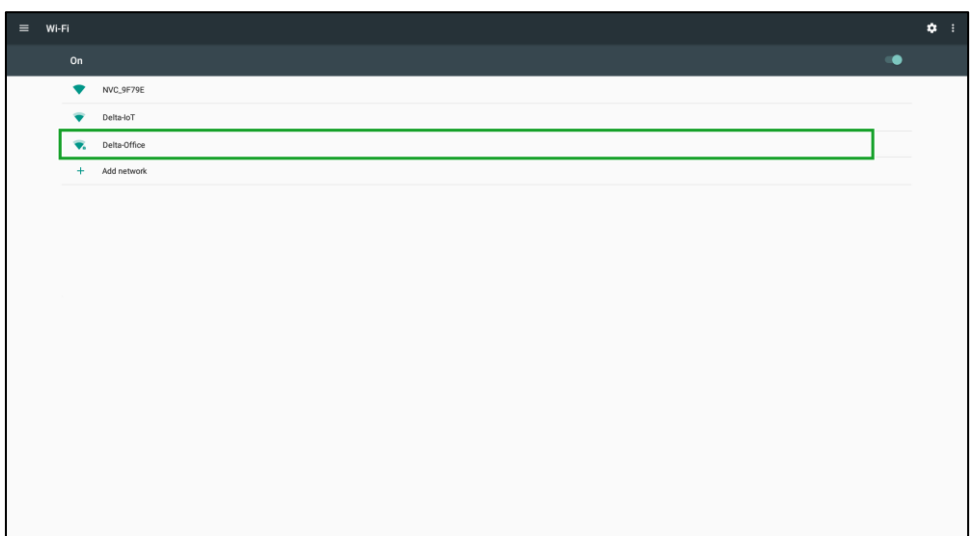

10. Enter a security password if necessary.

## Display Settings

The display settings menu is an On-Screen Display (OSD) menu which allows you to configure various video/audio related settings for the display. To open the display settings menu choose one of the following methods:

- Press the menu () button on the display.

DK430 / DK550

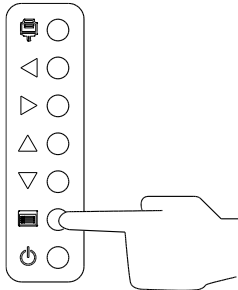

DK650 / DK750

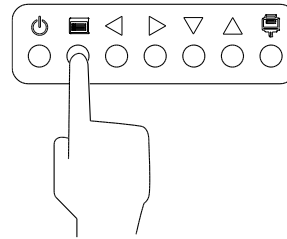



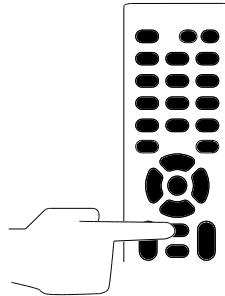





- Press the **Menu** button on the remote control.









To navigate the settings menu use the buttons on either the display or the remote control in the following manner:

### Using the buttons on the display:

- Press the left () or right () button to select a menu (e.g. the Sound menu).
- Press the up () or down () button to select the item in the menu that you want to adjust.
- Press the input source () button to confirm selection of the item that you want to adjust.
- Press the left () or right () button to change the setting on the item selected.
- Press the menu () button to return to the previous menu or exit the settings menu.

### Using the buttons on the remote control:

- Press the left () or right () button to select a menu (e.g. the Sound menu).
- Press the up () or down () button to select the item in the menu that you want to adjust.
- Press the **OK** button to confirm selection of the item that you want to adjust.
- Press the left () or right () button to change the setting on the item selected.
- Press the **Menu** button to return to the previous menu or exit the settings menu.

The display settings menu includes the following for sub-menus:

- Picture
- Sound
- Settings

**Picture**

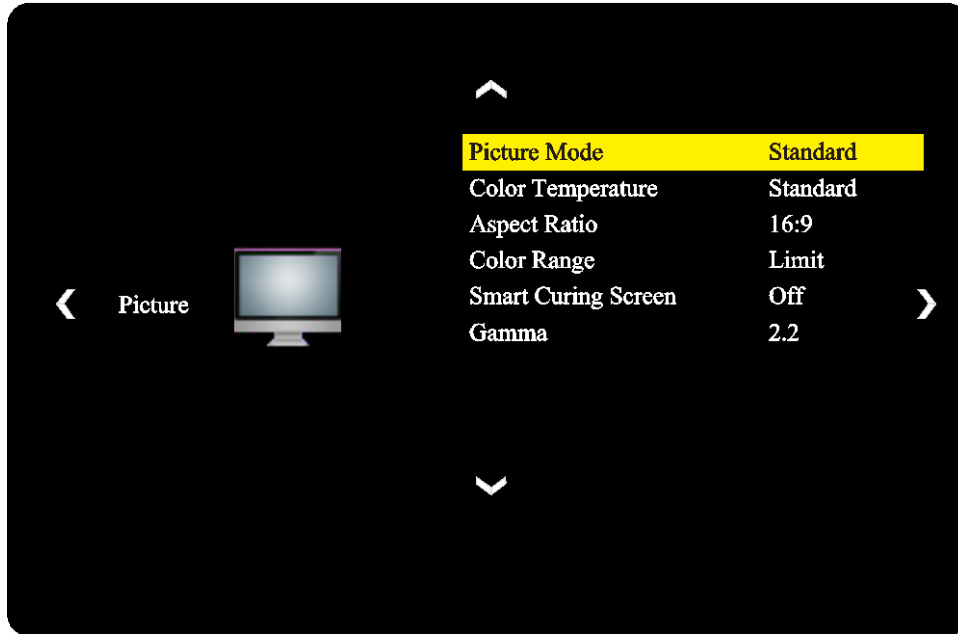

The **Picture** settings menu allows you to adjust the following settings:

Item	Description
Picture Mode	Changes the picture mode for the display. The available settings include: <b>Standard</b> , <b>Bright</b> , <b>Soft</b> , and <b>Custom</b> .
Color Temperature	Changes the color temperature for the display. The available settings include: <b>Standard</b> , <b>Warm</b> , <b>Cool</b> , and <b>Custom</b> .
Aspect Ratio	Changes the screen ratio for the display. The available settings include: <b>4:3</b> , <b>16:9</b> , <b>Cinema</b> , <b>Subtitle</b> , and <b>Computer</b> .
Color Range	Changes the RGB setting for an HDMI input signal. If the video features a “fuzzy” grey scale select <b>Full</b> in this field. The available settings include: <b>Limit</b> , and <b>Full</b> .
Smart Curing Screen	Enables/Disables the anti-burn-in function for the display’s screen. The available settings include: <b>On</b> and <b>Off</b> .
Gamma	Changes the gamma correction setting for the display. The available settings include: <b>2.2</b> and <b>2.4</b> .

Sound

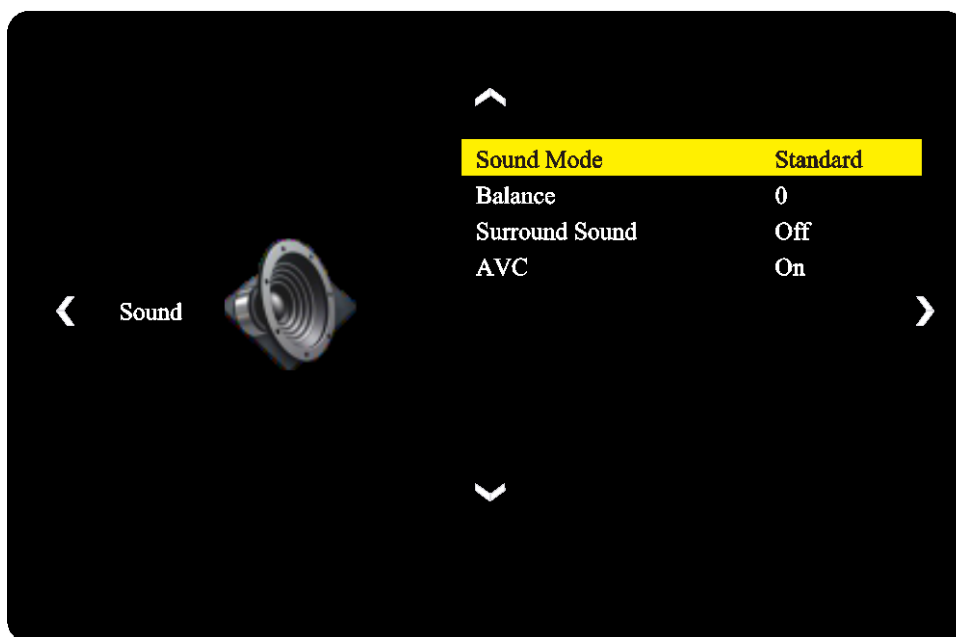

The **Sound** settings menu allows you to adjust the following settings:

Item	Description
Sound Mode	Changes the sound mode for the display. The available settings include: <b>Movie</b> , <b>Sports</b> , <b>User</b> , <b>Standard</b> , and <b>Music</b> .
Balance	Adjust the left/right audio balance for the display.
Surround	Enables/Disables Surround sound for the display.
AVC	Enables/Disables the Auto Volume Control for the display

Settings

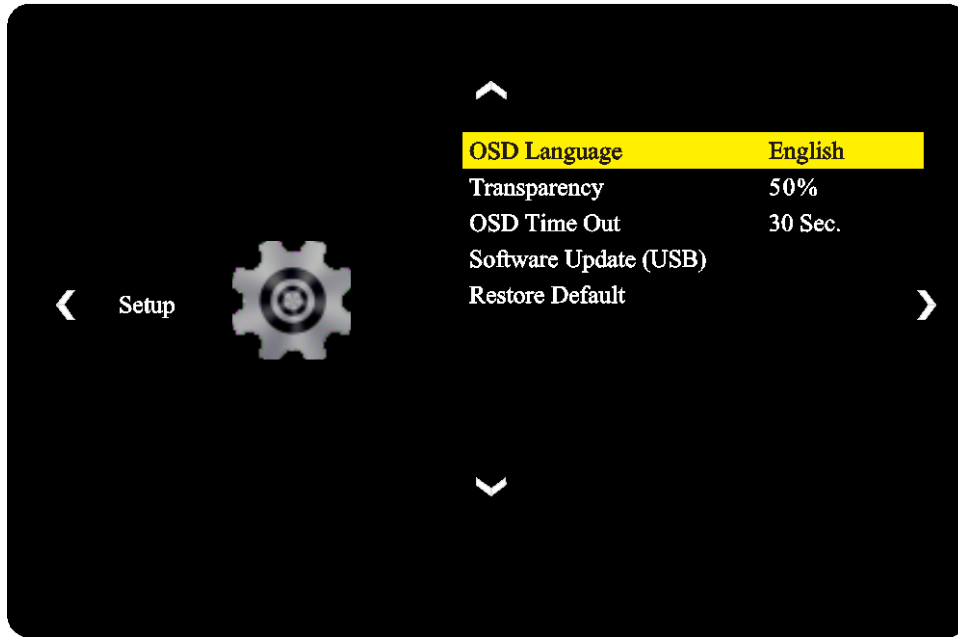

The **Display** settings menu allows you to adjust the following settings:

Item	Description
OSD Language	Changes the language for the settings menu. The available settings include: <b>English, French, Spanish, Portuguese, Italian, German, Russian, and Chinese.</b>
Transparency	Sets the level of transparency for the settings menu.
OSD Time Out	Sets the amount of inactive time before the settings menu automatically closes.
Software Upgrade (USB)	Upgrades the display's software from an upgrade file located on a USB flash drive connected to the display's USB port.
Restore Default	Restores the displays settings to their default values.

# Cleaning the Display

When cleaning the NovoDisplay display, please ensure you follow the instructions below to prevent damage to the display and its panel.

- Before you begin cleaning the display, ensure that it is powered off and unplugged from the power source. Then remove any styluses, pens, or accessories attached to the display.
- Do not use any chemicals on the panels.
- Do not use anything abrasive to wipe the display, use a clean soft, lint-free cloth instead to wipe the display.
- Do not spray water directly on the display, fill a spray bottle with water and spray directly on to the cleaning cloth instead. After wiping the display with the wet cleaning cloth use another clean soft, lint-free cloth to dry the display.
- Make sure all dust, debris, and smudges are removed from the display, ensuring that the corners and edges are also wiped clean.
- When wiping the display use a circular motion as seen in the image below:

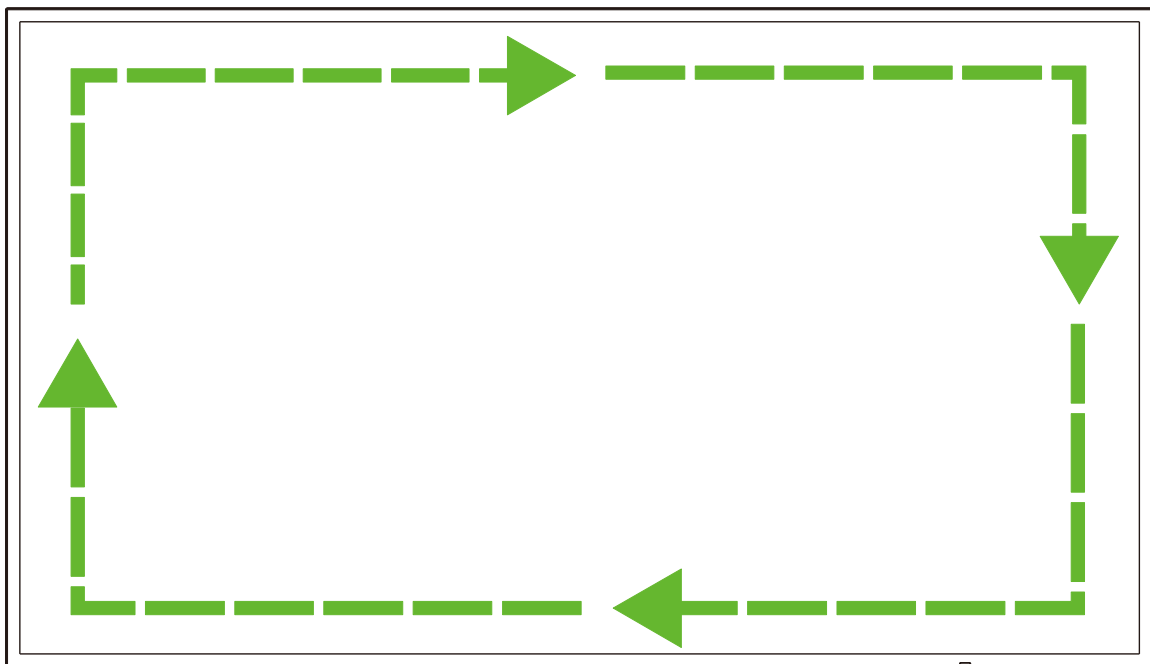



# Specifications

Model Name			NovoDisplay DK430	NovoDisplay DK550	NovoDisplay DK650	NovoDisplay DK750
Display Type/Size/Technology			43" Backlit D-LED	55" Backlit D-LED	65" Backlit D-LED	75" Backlit D-LED
Native Resolution			4K Ultra-HD (3840 x 2160)			
Viewing Angle (H/V)			178°/178°			
Aspect Ratio			16:9			
Response Time (MS)			6ms (Typ)		8ms (Typ)	
Pixel Pitch (HxV)			0.3268 mm x 0.2451 mm	0.420 mm x 0.315 mm	0.372 mm x 0.372 mm	0.429 mm x 0.429 mm
Refresh Rate			60Hz			
Viewable Area (H/V)			941.184 mm x 529.416 mm	1209.6 mm x 680.4 mm	1428.48 mm x 803.52 mm	1649.66 mm x 927.94 mm
Display Orientation			Landscape Only (No portrait mode support)			
Operating Hours			18/7			
Panel Connectivity	Input	Display	HDMI v2.0 (x2), DVI-D (x1), DisplayPort v1.2 (x1), VGA-In (x1)			
		Audio	Audio-In (3.5mm) (x1)			
		Control	RS-232 (RJ45) (x1)			
	Output	Display	DVI-D (x1)			
		Audio	Display: Audio-Out (3.5mm) (x1) / OPS Module: Audio-Out (3.5mm) (x1)			
		Control	RS-232 (RJ45) (x1)			
	USB	Rear	USB 2.0 (x1) (Support up to 32GB)			
OPS Module	OPS Interface		Standard (80pin)			
	System	OS Version	Android™ v7.1			
		RAM	2GB DDR3			
		Internal Storage	16GB (eMMC Flash) (Standard)			
	Connectivity	microSD Slot	Yes (Support up to 32GB) (x1)			
		USB	USB 2.0 (x2) (Support up to 32GB), USB-C (x1) (For Service Only)			
		LAN	RJ-45 (10x100x1000) (x1)			
		Wi-Fi	802.11 ac/b/g/n			
		Audio	Audio-Out (3.5mm ) (x1)			
	Control	RS-232 (x1)				
Audio	Internal Speakers		5W (x2) (Stereo)		8W (x2) (Stereo)	15W (x2) (Stereo)
Environmental Conditions	Operating	Temperature	0°C - 40°C (32°F - 104°F)			
		Humidity	20% - 85%			
	Storage	Temperature	-10°C - 60°C (14°F - 140°F)			
		Humidity	10% - 90%			
	Altitude		Below 5,000m (16,400ft)			
Physical Characteristics	Dimensions (L x H x D) (Estimated)	FPD	969.9 x 558.3 x 84.8mm (38.2" x 22" x 3.3")	1,243.2mm x 714mm x 69.6mm (48.9" x 28.1" x 2.7")	1,476.7 x 851.7 x 79.8mm (58.1" x 33.5" x 3.1")	1,714.2 x 992.4 x 97.2mm (67.5" x 39.0" x 3.8")
	Weight (Estimated)	Net	9kg (19.84lbs)	15kg (33lbs)	39kg (85.9lbs)	41kg (90.4lbs)
	Available Color		Black			
Standard Accessories			AC Power Cord, OPS Module, Antenna (x2), Remote Control, Wall Mount Kit, Documentation Kit			

# Troubleshooting

## If the display does not function normally

Remote control failure	1	Check whether there are other objects between the remote control and the IR sensor window, thus leading to remote control failure.
	2	Check whether the battery electrodes in the remote control are in the correct orientation.
	3	Check whether remote control needs to replace its batteries.
Machine automatically shuts down	1	Check whether sleep is set or not.
	2	Check whether there has been a sudden power outage.
	3	Check whether there is a signal (the display may power off after a period of inactivity).

## PC mode issues

Signal is out of range	1	Check whether the display is setup correctly.
	2	Check whether the resolution is the best resolution.
Background has vertical lines or streaks	1	Select auto correction in the OSD settings menu.
	2	Adjust the clock and phase values in the OSD settings menu.
Image lacks color or the color is incorrect	1	Check whether the video cables are well connected or have quality problems.
	2	Adjust brightness or contrast values in the OSD settings menu.
The display format is not supported	1	Select auto correction in the OSD settings menu.
	2	Adjust the clock and phase values in the OSD settings menu.

## Videos do not function normally

No picture and no sound	1	Check whether the machine is in a powered state.
	2	Check whether signal cable is plugged in correctly, and whether the correct input source is selected.
	3	If the display is in internal computer mode, check whether internal computer is started.
The image features horizontal or vertical stripes or image dithering	1	Check whether signal cable is plugged in correctly.
	2	Check whether other electronic equipment or power tools are placed around the machine.
No color, color is weak, or image is weak	1	Adjust brightness or contrast values in the OSD settings menu.
	2	Check whether signal cable is plugged in correctly.

## Audio does not function normally

Images is shown without sound	1	Check whether the mute button has been pressed.
	2	Press VOL + / - to adjust volume.
	3	Check whether the audio line is connected correctly.
Only one speaker has sound	1	Adjust the sound balance in the OSD settings menu.
	2	Check whether the computer's sound control panel has only set up one sound channel.
	3	Check whether audio line is connected correctly.
VGA output is shown without sound	1	Check whether the audio out jack of the external device is connected to the audio in jack.

# Appendix (RS-232 Specifications)

The following are the command codes for the RS-232 port:

Command	Code
Power On	E5 FD 20 AE 4F
Power Off	E5 FD 20 AD 50
Input Source	E5 FD 20 B6 47
Settings Menu	E5 FD 20 B1 4C
OK	E5 FD 20 B0 4D
Up	E5 FD 20 B2 4B
Down	E5 FD 20 B3 4A
Left	E5 FD 20 B4 49
Right	E5 FD 20 B5 48
Rewind	E5 FD 20 C2 3B
Fast Forward	E5 FD 20 C3 3A
Play	E5 FD 20 C4 39
Pause	E5 FD 20 C5 38
Stop	E5 FD 20 C6 37
Next	E5 FD 20 DC 21
Previous	E5 FD 20 DD 20
Rotate	E5 FD 20 DE 1F
Volume Up	E5 FD 20 C7 36
Volume Down	E5 FD 20 C8 35
Mute	E5 FD 20 C9 34
Exit	E5 FD 20 DB 22
Zoom	E5 FD 20 DF 1E
Backlight On	E5 FD 20 73 8A
Backlight Off	E5 FD 20 72 8B
Switch Input Source to HDMI1	E6 FD 20 50 00 AC
Switch Input Source to HDMI2	E6 FD 20 50 01 AB
Switch Input Source to OPS	E6 FD 20 50 02 AA
Switch Input Source to DVI	E6 FD 20 50 03 A9
Switch Input Source to DisplayPort	E6 FD 20 50 04 A8
Switch Input Source to USB	E6 FD 20 50 05 A7
Switch Input Source to VGA	E6 FD 20 50 06 A6
Enter Manufacturer's Menu	E5 FD 20 AF 4E

# Copyright Statement

## Copyright

The user manual (including all pictures, illustrations and software) is protected by the international copyright right law. All rights are reserved. No duplication of the manual or any content included in the manual is allowed without the written consent of the manufacturer.

Vivitek is the trademark of Delta Electronics, Inc. ©All rights reserved. 2019

## Disclaimer

The information in the manual is subject to change without notice. The manufacturer does not provide any statement or warranty of the contents in the manual and clearly give up the implied warranties of merchantability and of fitness for a particular purpose. The manufacturer reserves the rights to modify the publication and change the contents of the materials at any time without notice to any person.

## About the Manual

The manual describes how to install and use the display and is applicable to the end-user. Relevant information (such as illustrations and descriptions) is put on the same page as possible as we can. The format, easy for printing, is convenient for reading and paper-saving which is beneficial to environmental protection. It is suggested printing the page you need.



**Vivitek Americas**

46101 Fremont Blvd, Fremont, CA 94538

U.S.A.

T: +1-510-668-5100

F: +1-510-668-0680

**Vivitek Asia**

7F, No. 186, Ruey Kuang Road, Neihu, Taipei 11491

Taiwan R.O.C.

T: +886-2-8797-2088

F: +886-2-6600-2358

**Vivitek Europe**

Zandsteen 15, 2132 MZ Hoofddorp

The Netherlands

T: +31-20-800-3960

F: +31-20-655-0999

[www.vivitekcorp.com](http://www.vivitekcorp.com)